

GS-2000 GS-3000

SERIES

MAXIMUM PERFORMANCE CNC TURNING CENTERS

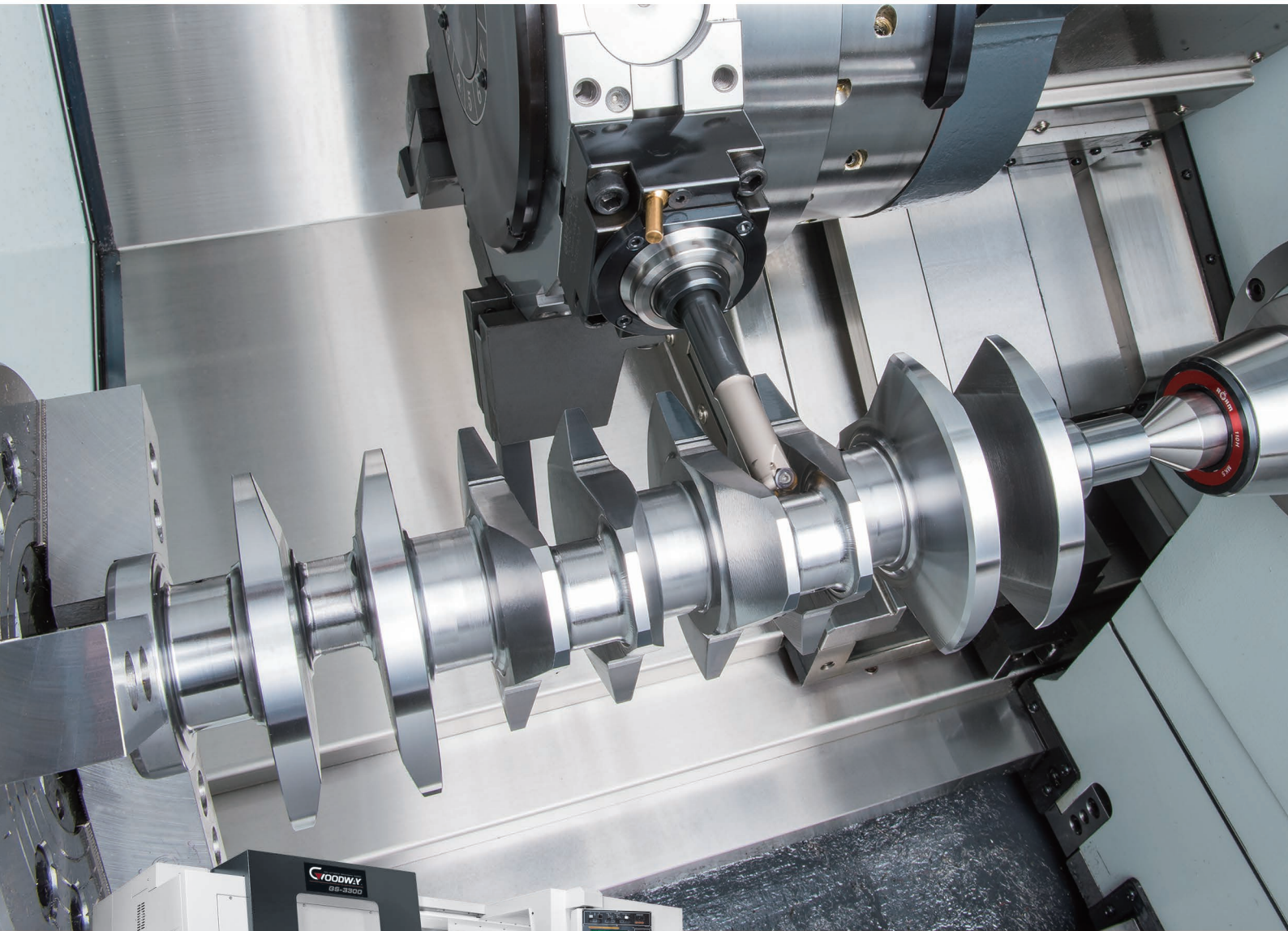

THE ULTIMATE MACHINING POWER
WOODWAY

MAXIMUM PERFORMANCE CNC TURNING CENTERS

With the latest machine tools technology and powerful turning performance, GOODWAY brings you the new GS-2000 / GS-3000 series maximum performance CNC turning center. Using 2 different lengths of beds and 5 different sizes of bar capacities combined with a powerful spindle, high speed servo indexing turret and high rigidity structure design, the GS-2000 / GS-3000 series becomes the best choice of machine tools for the new generation. Additionally, it can be equipped with an optional precision built-in type spindle, high torque gear type spindle, or a live tooling turret, Y-axis and sub-spindle which can accomplish mutli-tasking applications. With the perfect quality and complete tasking capabilities, the GS-2000 / GS-3000 series can easily various needs of today and tomorrow.









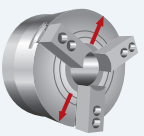

- ▶ The modern 30° slant-bed design ensures outstanding structural rigidity and heavy-duty cutting ability.
- ▶ All standard turrets and live tooling turrets are self-developed and assembled by GOODWAY which ensures high quality of the key components and allows the machine to provide optimal performance.
- ▶ Spindle is driven by the wide-range FANUC α P series motor which can take heavier cuts in low RPM ranges.
- ▶ Extra large Z-axis servo motors provide the thrust needed to efficiently drill big diameter holes.
- ▶ Coolant system with roll-out coolant tank and high-pressure coolant pump.

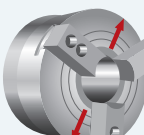

(GS-3300 model shown.)

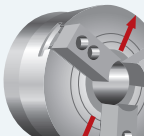

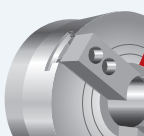
(GS-3600L model shown with optional accessories.)

| Chuck Size | Max. Turning Length*1 | Bar Capacity |
|--|---|---|
|  8" | 750 mm GS-2000 GS-2000L 1,500 mm |  Ø 51 mm |
|  10" | GS-2600 GS-2600L |  Ø 65 mm |
|  10" | GS-2800 GS-2800L |  Ø 75 mm |
|  12" | GS-3300 GS-3300L |  Ø 90 mm |
|  15" | GS-3600 GS-3600L |  Ø 105 mm |

Optional Multi-Tasking Accessories



M Live tooling turret

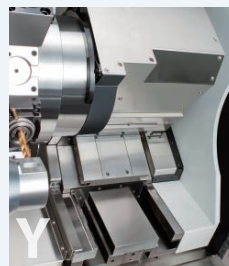

Y-axis



S Sub-spindle

*1 Maximum turning length may vary, based on the model chosen.

ULTIMATE TURNING POWER

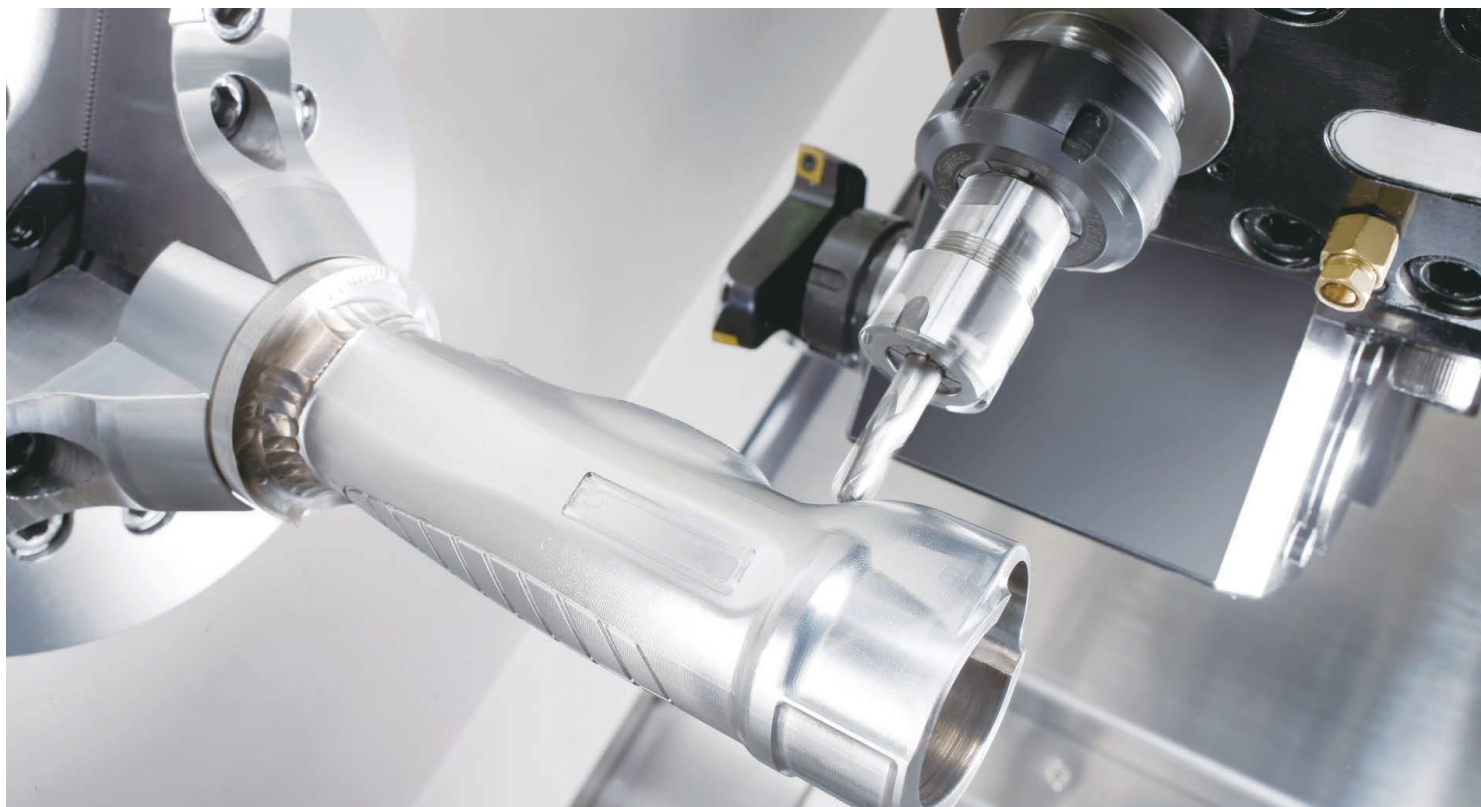

Work-piece Material : S45C

Test Model : GS-3600M

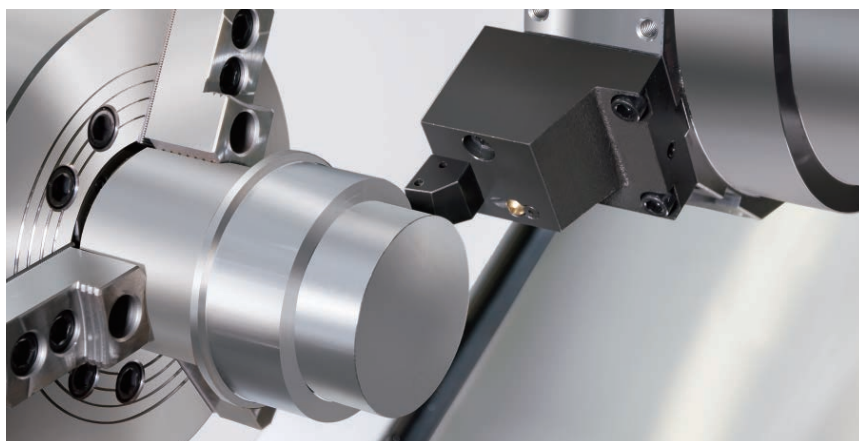

Heavy Cutting

7
Depth of Cut (mm)

0.4
Feed Rate (mm/rev.)

417
Speed (rpm)

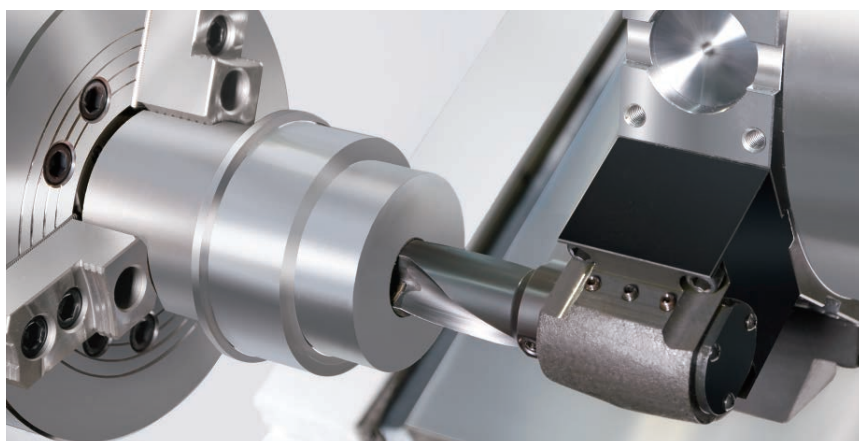

U-drill

50
Tools Diameter (mm)

0.15
Feed Rate (mm/rev.)

764
Speed (rpm)



Tapping

M16 x P2.0

Tools Diameter (mm)

240

Tool Speed (r/min.)

530

Feed Rate (mm/min.)

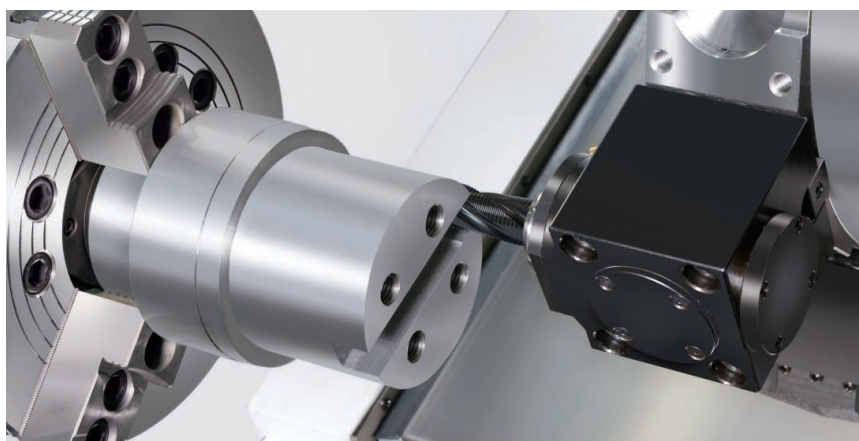

End Mill

15

Depth of Cut (mm)

20

Tool Dia. (mm)

640

Speed (rpm)

260

Feed Rate (mm/rev.)

MAXIMUM STRENGTH CONSTRUCTION

- ▶ By using Finite Element Methods (FEM), optimal reinforce ribbings are directly cast into the one-piece bed structure. Mechanical rigidity has been increased by more than 30% when compared to conventional designs. The GS-2000 / GS-3000 series is capable of performing super heavy-duty turning and maintain long-term super high-precision accuracy. More rigidity also means extended tool life.
- ▶ Major structural components have been combined into one solid platform. The low center of gravity 30° slant-bed design provides the most rigid foundation possible for the headstock, turret, and tailstock.
- ▶ Built to endure years and years of rigorous high production turning, the heavily ribbed, one-piece thermally balanced bed and casting components are of FC35-MEEHANIT casting. FC35 grade cast iron is capable of withstanding much greater stress without deforming and provides maximum vibration dampening, which result in a machine that will outlast and outperform the competition.
- ▶ X and Z axes are driven by over-sized FANUC α i series absolute AC servo motors, providing tremendous thrust outputs with faster acceleration and deceleration. Absolute encoder technology saves time and money by eliminating the use of limit switches, thus, eliminating referencing axes to home positions and replacing broken limit switches.

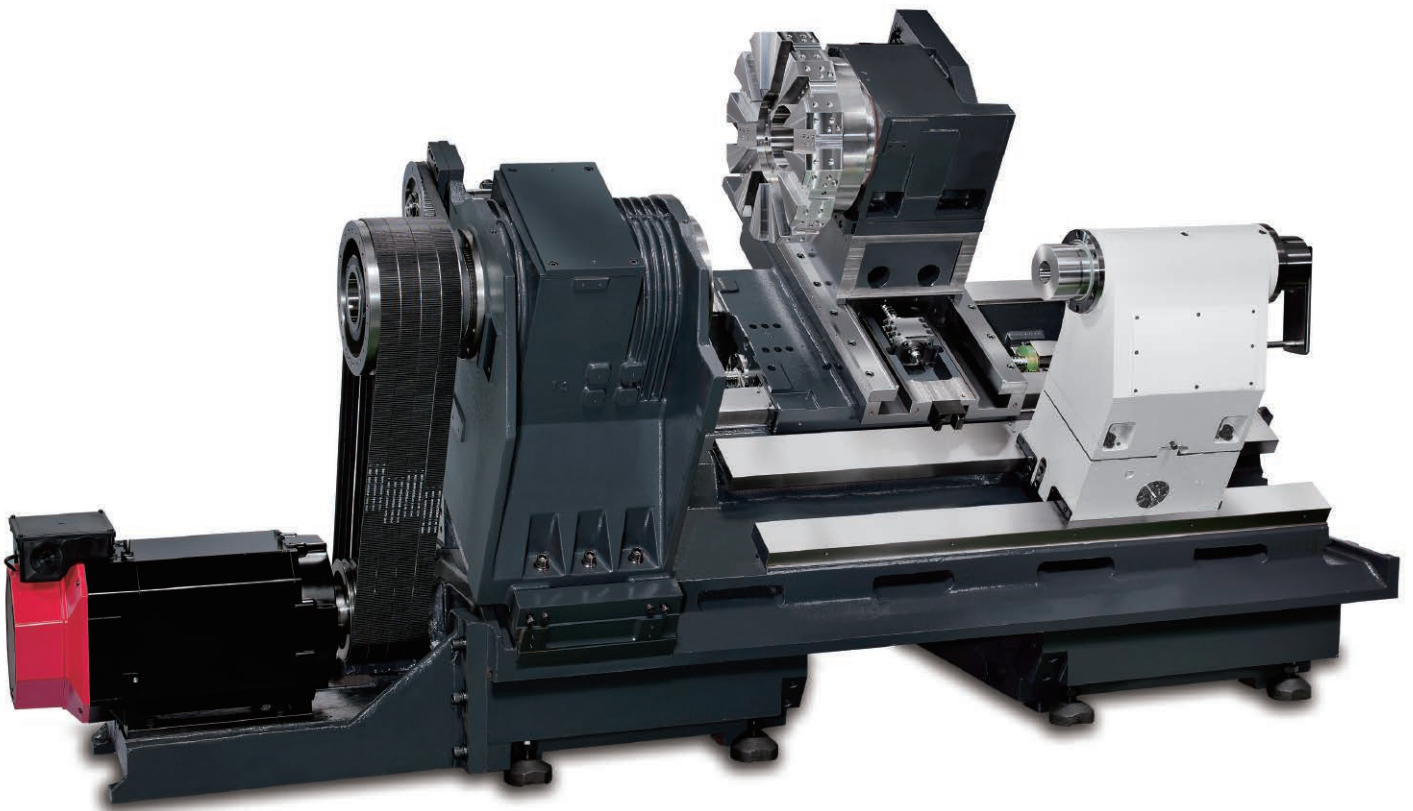
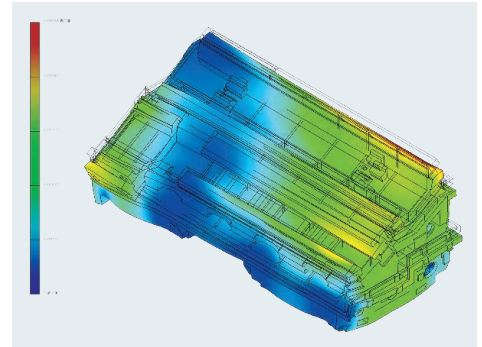

(Casting structure of GS-3300 Series model shown.)

- ▶ Contact surfaces of all slides, headstock, turret, tailstock, and ball screw bearing housings with the machine bed are precision hand scraped to provide maximum assembly precision, structural rigidity, and load distribution.

- ▶ C3 class hardened and precision ground ball screws ensure the highest accuracy and durability possible. Plus, pretension on all axes minimizes thermal distortion.

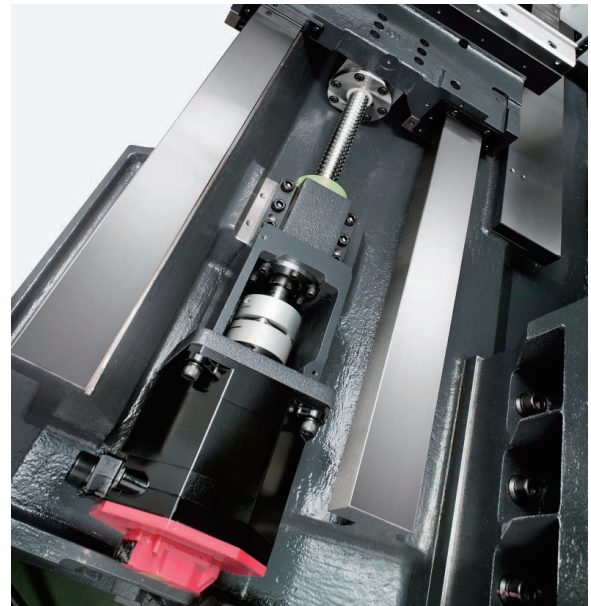
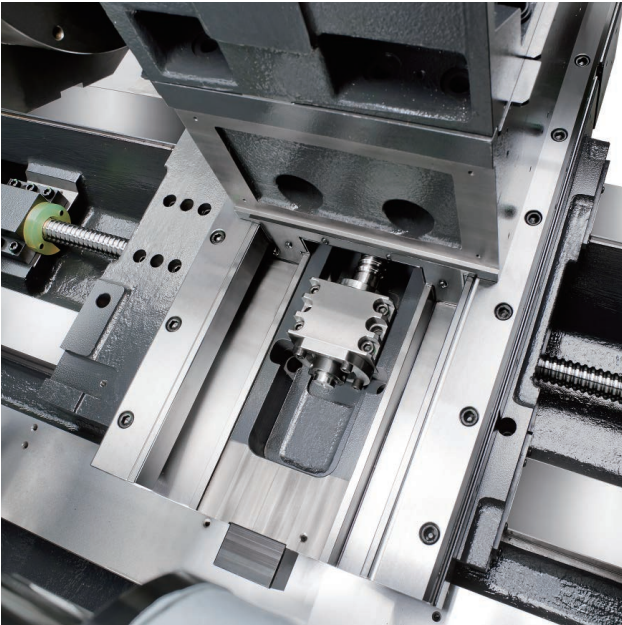

- ▶ Extra wide hardened and ground box ways are directly formed onto the machine bed and saddle during the casting process. They are precision machine and widely spaced for maximum strength. The box way design also provides the rigidity needed for heavy cutting and interrupted turning applications.

GS-2000 / GS-3000 Series V.5 Previous Model

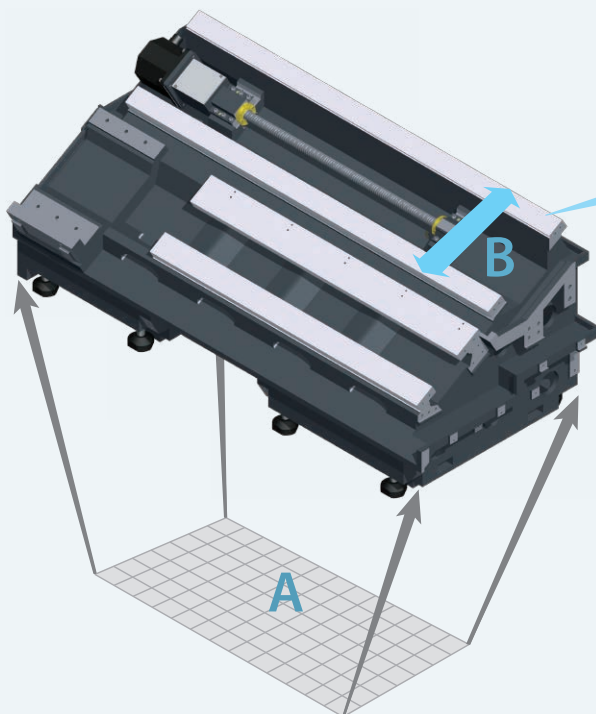

A | **11%**
Bed Floor Space Increased

C | **14%**
Slideway Width Increased

B | **23%**
Slideway Span Increased

D | **25%**
Slideway Thickness Increased

HIGH PERFORMANCE SPINDLE SYSTEM

- ▶ P4 grade (Class 7) super-high precision bearings are directly assembled for maximum level of support and precision. Bearing configuration is designed for super heavy-duty cutting with ultra-smooth performance and long term durability with a higher level of accuracy.
- ▶ The A/C, constant output, wide-range FANUC α P series motor can generate twice the torque output of standard motors. This double bind motor is designed to reach full output at 1/2 the RPM of standard motors, providing the ability to take heavier cuts in the lower RPM ranges.



E 22%
Headstock Contact
Surface Increased



- ▶ The super large headstock is heavily ribbed and of one-piece casting. The contact surfaces between the headstock and bed are greatly increased which provides greater rigidity of the headstock and efficiently dampens vibration, therefore, increasing machining accuracy.

Built-in Spindle

- ▶ The optional built-in type spindle can provide 100% motor output. It can decrease vibration generated from the spindle while spinning, thus increasing the life span of the spindle and increasing machining accuracy.
- ▶ The built-in spindle is covered with a cooling water jacket and equipped with an external oil cooler which efficiently reduces thermal expansion and ensures long term machining accuracy.

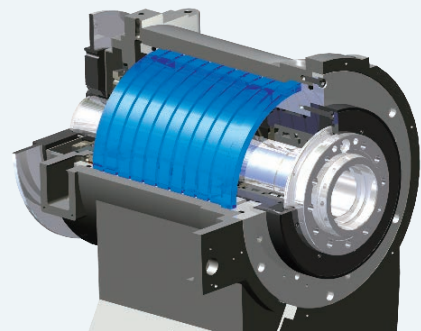

ZF Gear Box

- ▶ The optional oil bath GERMAN made ZF 2-step gear box provides maximum torque up to 1,200 Nm, which can easily meet with heavy cutting requirements.

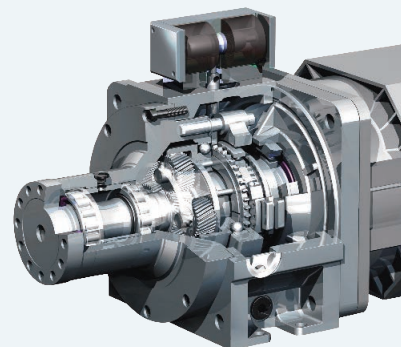

GS-2000 Series Spindle Output

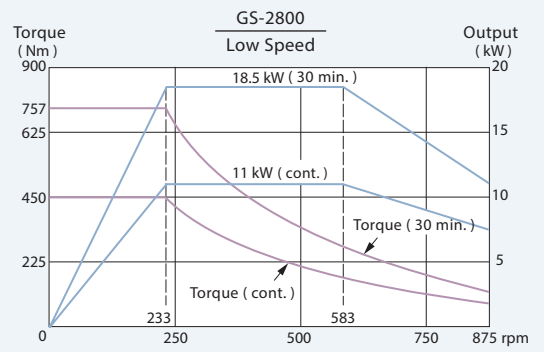
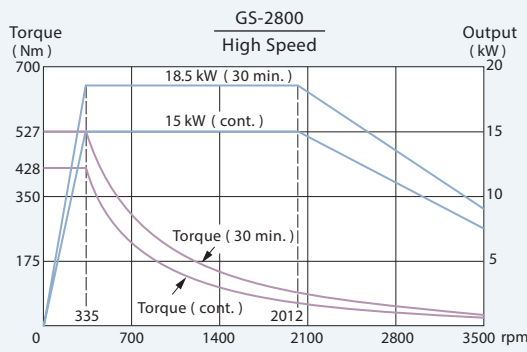
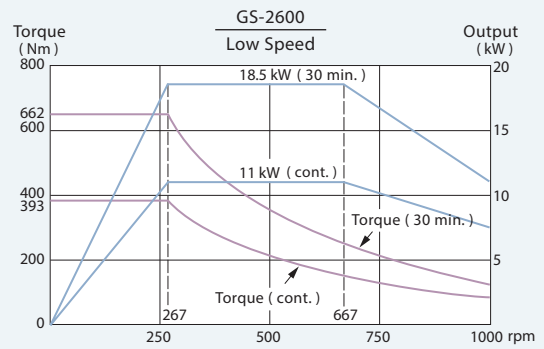
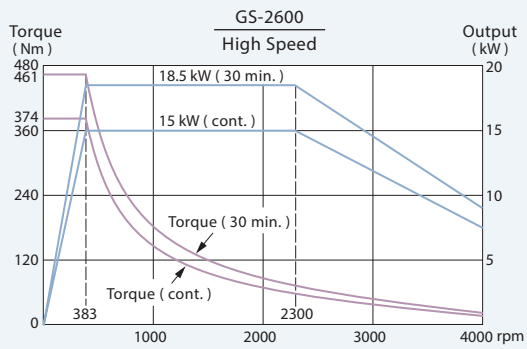
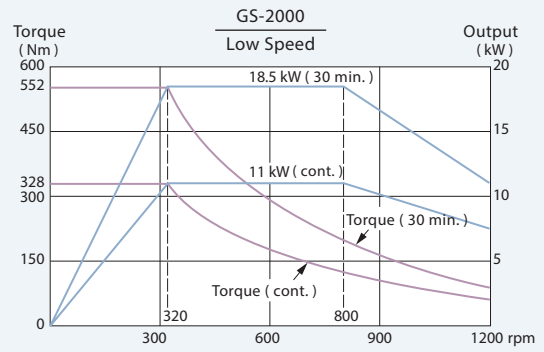
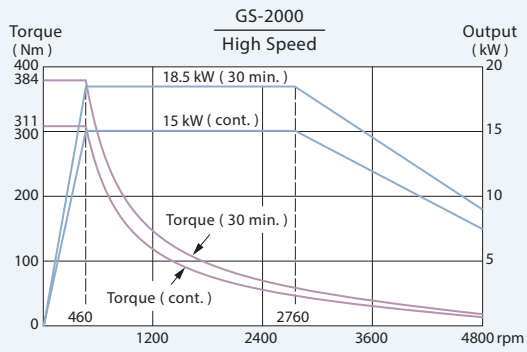

GS-3000 Series Spindle Output

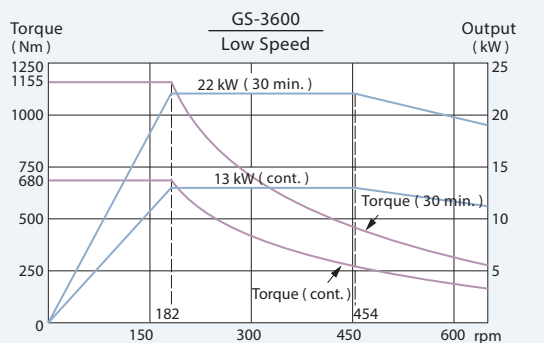
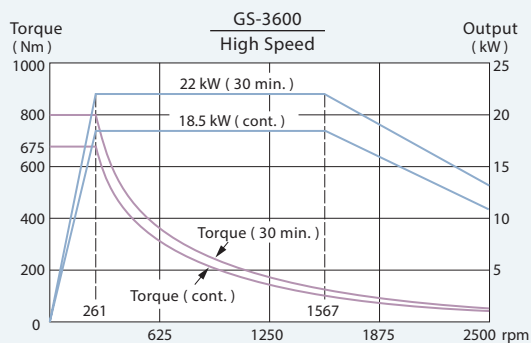
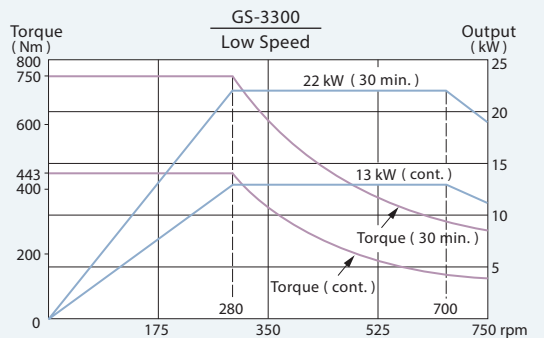
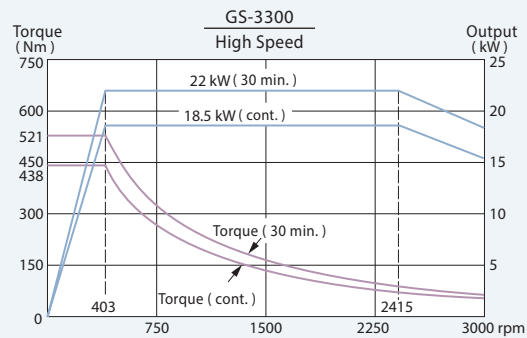

ADVANCED TURRET TECHNOLOGY

- ▶ GOODWAY all series turrets are equipped with JAPAN made curvic couplings which is precision assembled under A/C controlled laboratory which ensures powerful cutting performance, outstanding quality and long life span.
- ▶ The heavy-duty servo indexing turret achieves 0.3 second indexing times for adjacent stations and 0.8 second for stations at the opposite end of the disk. Index movements are single step, without pauses, no matter how many stations are skipped.

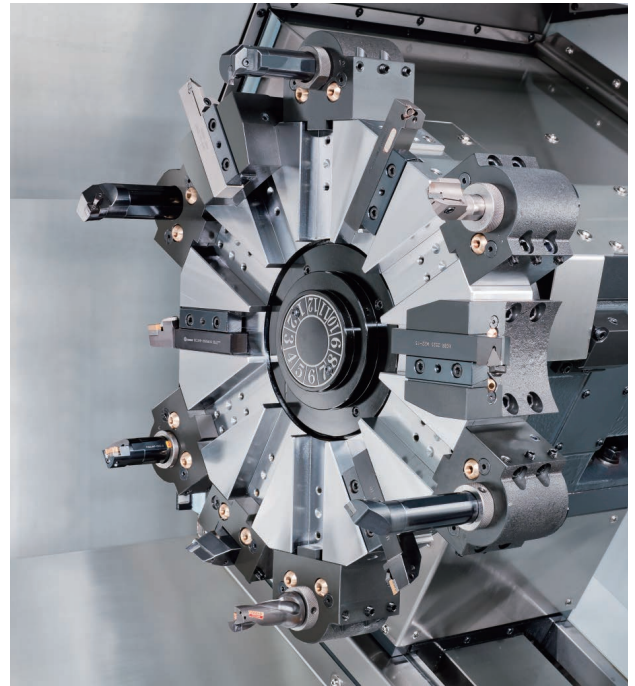

Indexing Time

0.3

Adjacent (sec.)

0.8

180 degrees (sec.)

- ▶ The large diameter super high precision curvic couplings accurately position the turret disk and the powerful clamping force ensures abundant turret rigidity for all cutting conditions.

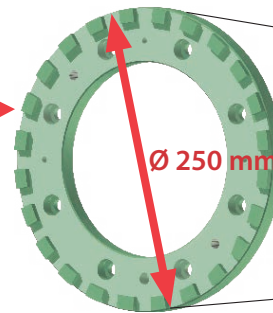
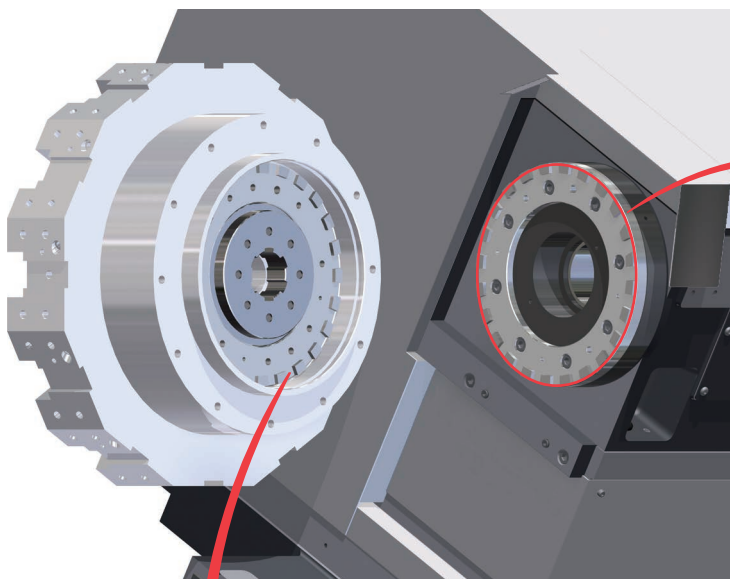

GS-2000 / GS-3000 Series

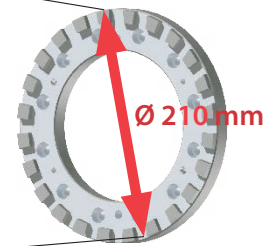

Previous Model

Curvic Coupling

19%
Diameter Increased

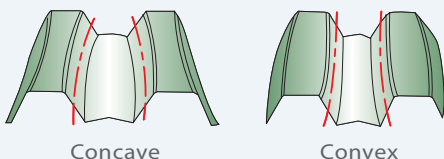

Curvic Coupling

- ▶ The curvic coupling provides self-centering, self-cleaning and large contact surface advantages compared to conventional curvic couplings.

HIGH RIGIDITY TAILSTOCK

- ▶ Programmable servo type tailstock combined with a complete software interface can easily accomplish difficult processing tasks while simplifying the tailstock positioning procedure to save manpower.

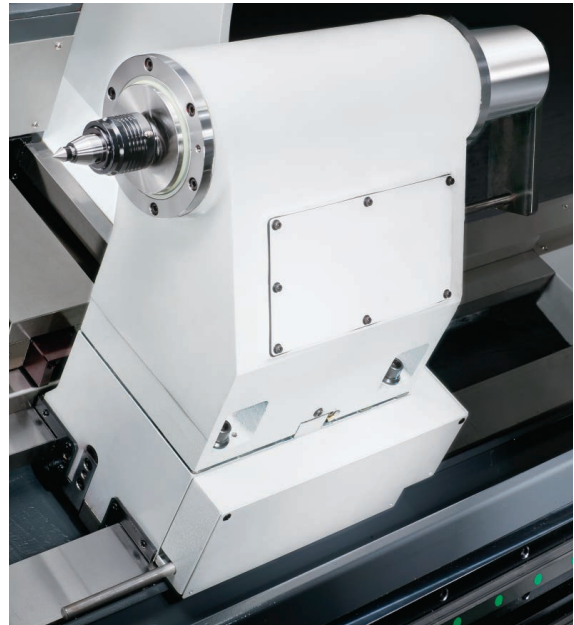

S Standard **O** Option — Not Available

| Quill Type | MT#3 | MT#4 | | MT#5 |
|------------|-------------|-------------|-------------|-------------|
| | Dead Center | Dead Center | Live Center | Live Center |
| GS-2000 | S | — | O | — |
| GS-3000 | — | S | — | O |



Quill Programmable Tailstock

- ▶ The Z-axis carriage automatically locks on to the base of the tailstock and drags it to the desired position.
- ▶ The built-in bearing quill provide greater rigidity for heavy loads. The extension and retraction of the quill is programmable and thrust pressure adjustable.
- ▶ B-axis is adopted with super rigidity box way design.

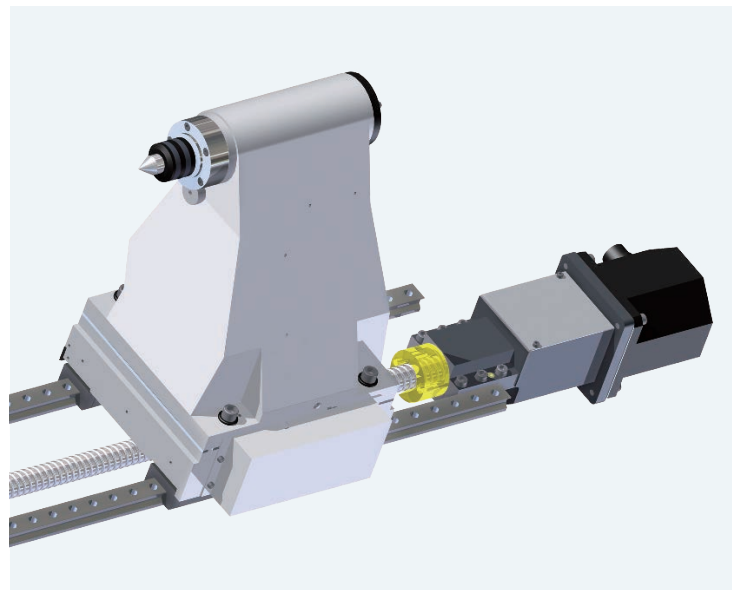

Servo Tailstock

- ▶ The tailstock base positioning is driven by a ball screw and direct-drive servo motor.
- ▶ The super rigidity fixed type quill and tailstock is of one piece, combined with a powerful thrust servo motor, can ensure optimal machining accuracy.
- ▶ The B-axis is adopted with super rigidity roller guide ways design.

LIVE TOOLING TURRET

- ▶ Live tooling and C-axis control capabilities on the GS-2000 or GS-3000 series allows the machine to perform multiple tasks on a work-piece, such as turning, milling, drilling and tapping. It eliminates manpower and cycle time, while reducing accuracy lost, which will occur if the part is moved from machine to machine.
- ▶ The live tooling turret is mated with a 4.5 kW motor and driven by a transmission mechanism to provide tremendous amount of horsepower which can easily accomplish difficult tasks such as milling, drilling and tapping.
- ▶ The 12-station live tooling turret offers 12 stations available for live tooling, live tools rotate in working position only to reduce power loss and heat.



ULTIMATE C-AXIS SPINDLE

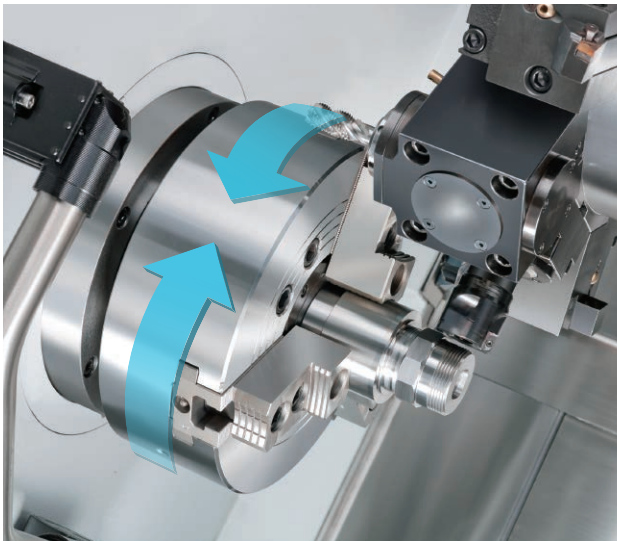

- ▶ The Cf-axis and disk brake system available on the GS-2000 / GS-3000 series provides the most rigid and powerful type of C-axis on the market today.
- ▶ Working with the live tooling turret, the Cf-axis and disk brake system enables the machine to perform multiple tasks, such as drilling, tapping, and milling operations, including cylindrical and polar coordinate interpolations (resembling a 4th-axis rotary table on a machining center).
- ▶ With the FANUC servo motor generating an ultra high resolution of 120 million pulses per spindle rotation and 480 Nm of torque (cont.), machined surface finishes can reach to a higher accuracy level. Plus, dynamic accuracy is within $\pm 0.02^\circ$.

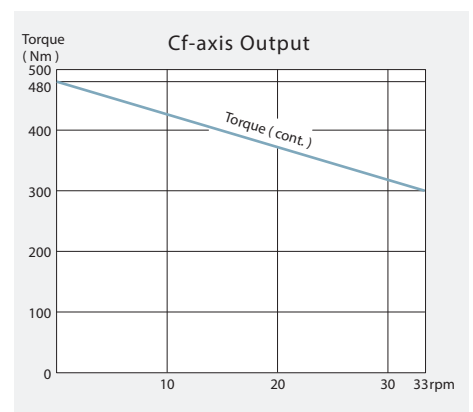
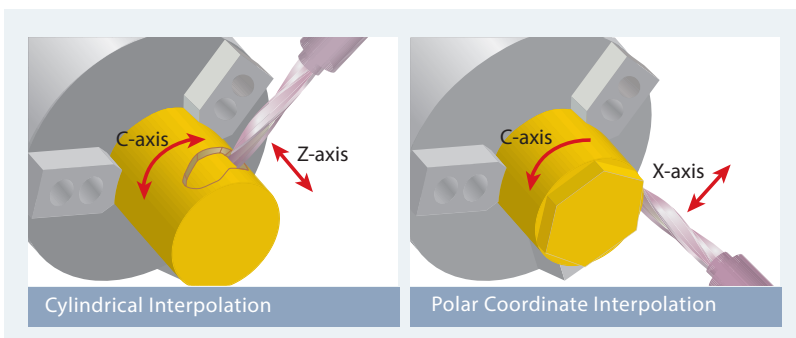

Y-AXIS MACHINING CAPABILITY

- ▶ The Y-axis combined with live tooling turret, C-axis and high torque live toolings enhances multi-tasking live tooling capabilities and improves various machining precision. High precision grooving and X-axis off-center drilling are enabled.
- ▶ With an abundant amount of Y-axis travel, 100 mm = ± 50 mm (3.93" = ± 1.96"), a wide variety of parts may be efficiently machined.
- ▶ The Y-axis is adopted with low gravity, wide span box way design to ensure outstanding machining rigidity.

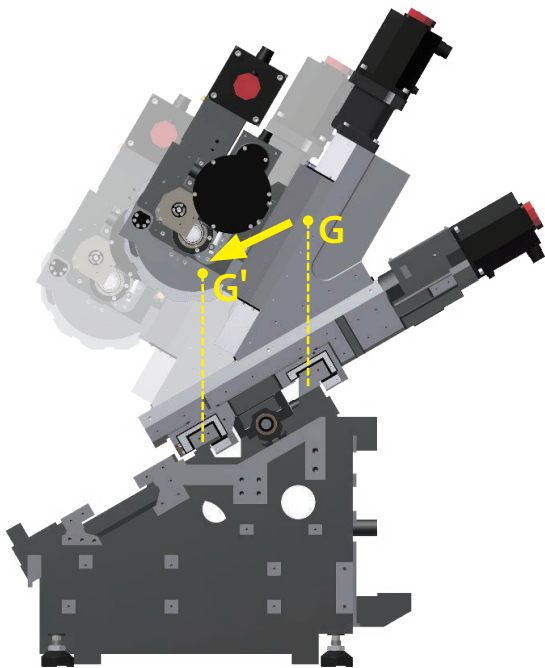
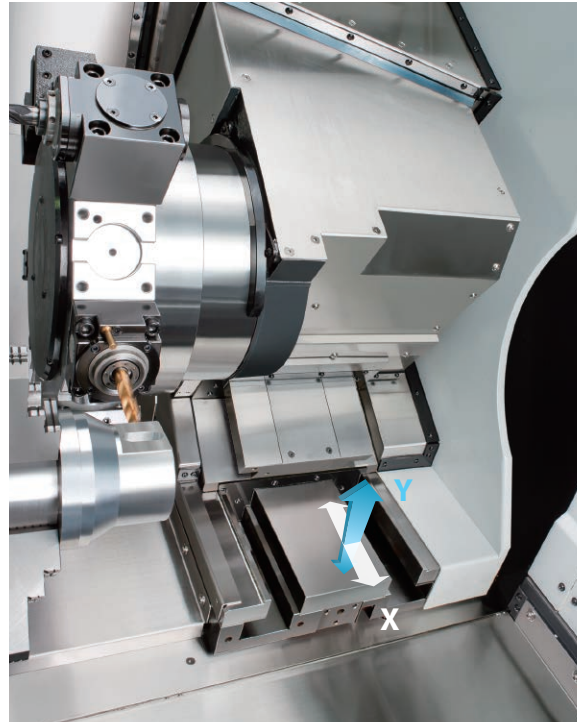

- ▶ On Y-axis equipped machines, the turret is mounted on a secondary 30 degrees wedge saddle on top of the X-axis slide. Both X & Y axes have extra wide hardened and ground box ways, which are directly formed onto the saddles during the casting process. They are precision machined and widely spaced for maximum strength.

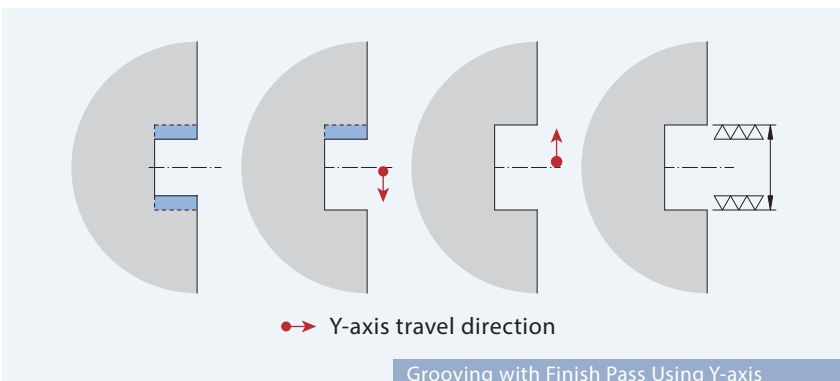
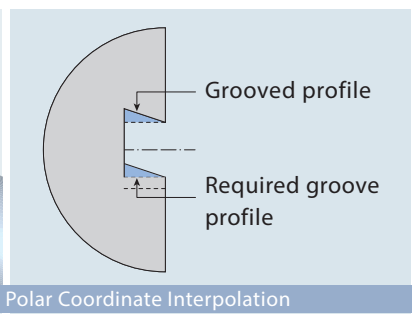
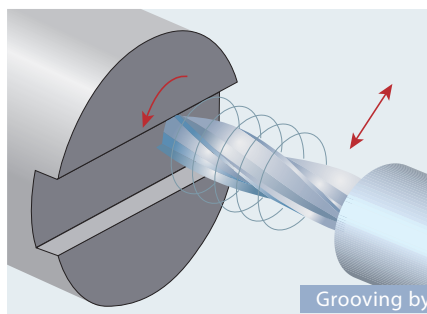
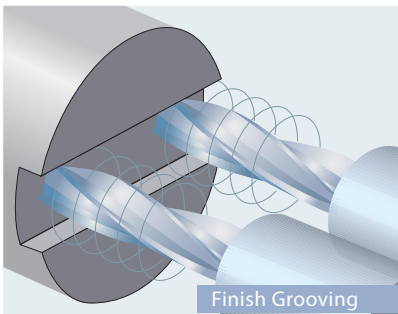

- ▶ Grooving with Y-axis control produces grooves with higher accuracy.

BACK-END MACHINING CAPABILITY

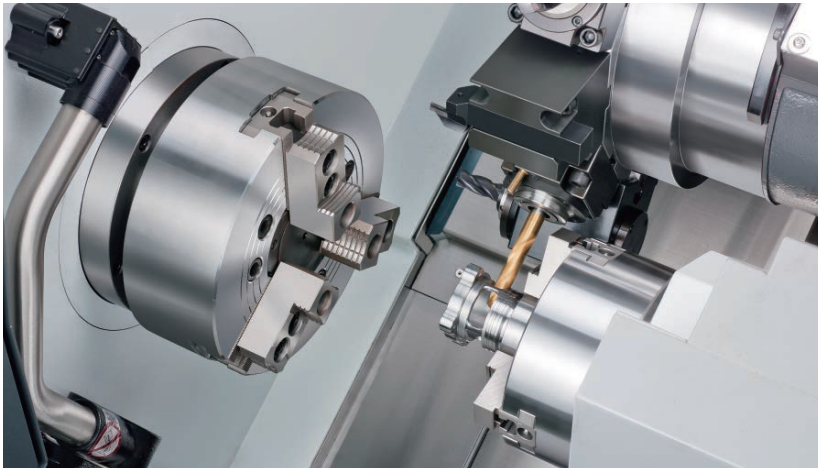

Sub-spindle Output

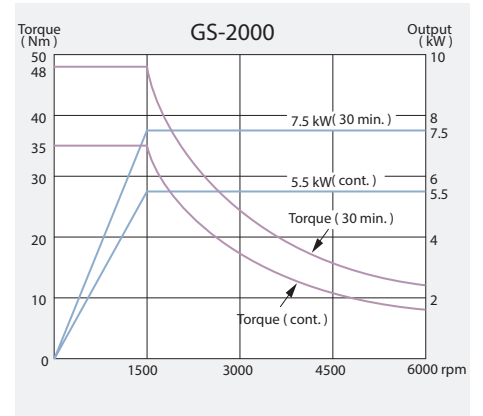

- ▶ With the optional sub-spindle, the working process is done-in-one from input to output, without having to manually flip over the work-piece, thus increasing productivity and machining accuracy.
- ▶ The B-axis movement of the sub-spindle is adopted with roller linear guideway design, to provide super rigidity, precision and fast movement (30 m/min.) performance.
- ▶ The sub-spindle can also be equipped with the C-axis function (same as the main spindle), to allow the contour positioning accuracy reach up to 0.001°. It can also accomplish back-end milling, drilling and tapping applications when combined with a live tooling turret.

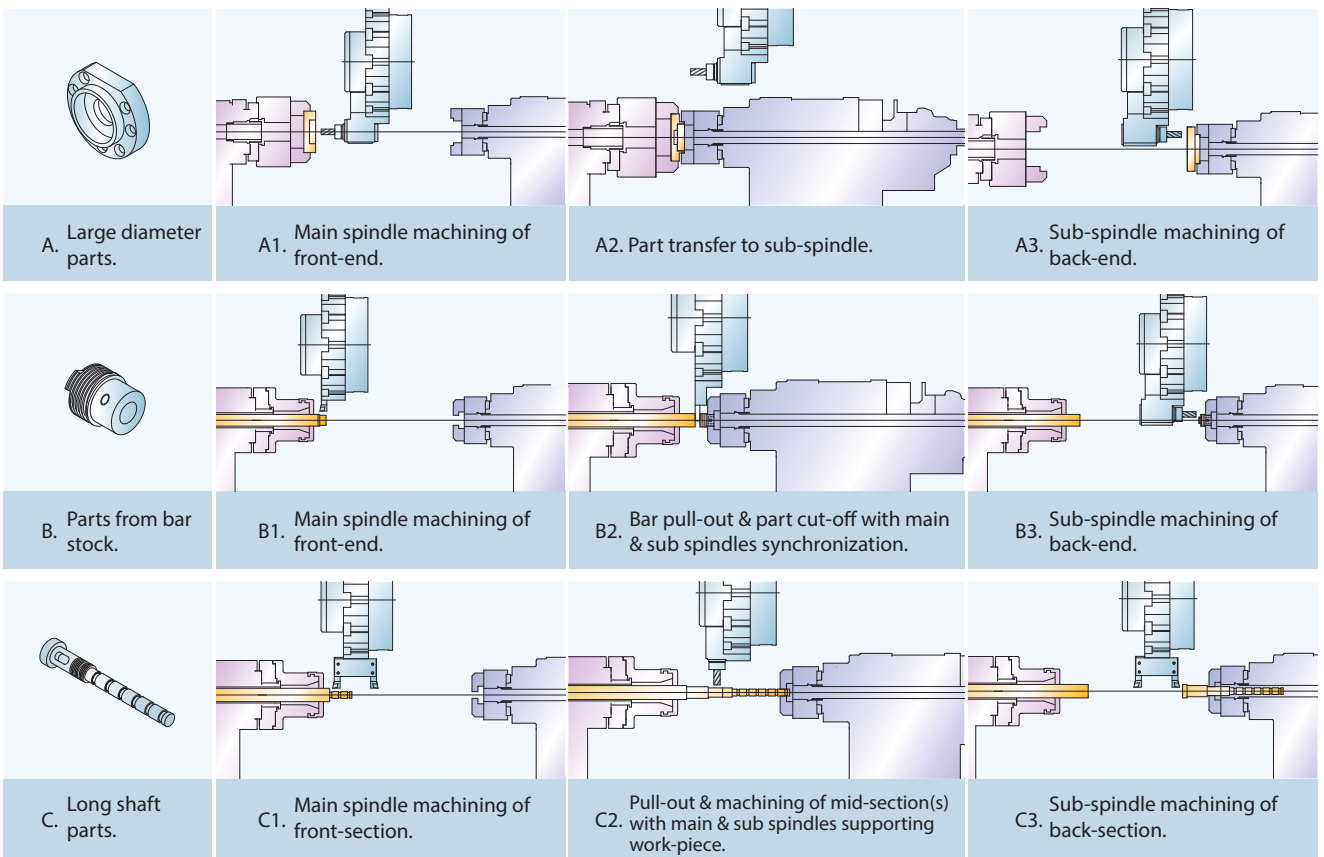
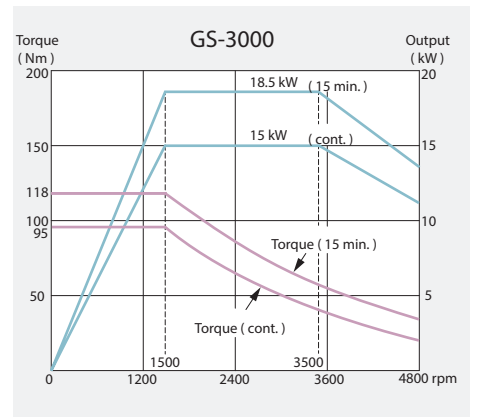

GENERAL DIMENSION

Interference Diagram

[12-Station Turret]

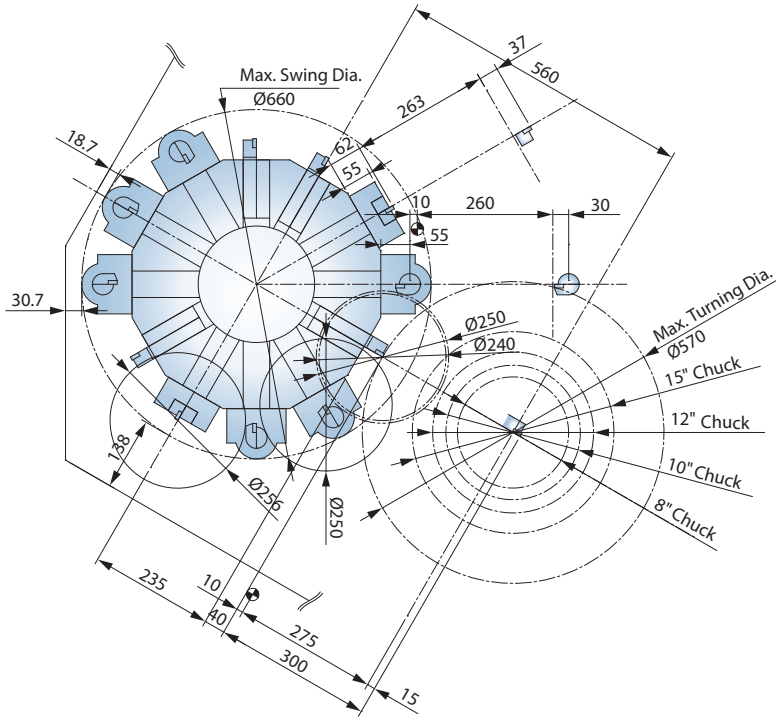

[12-Station Live Tooling Turret]

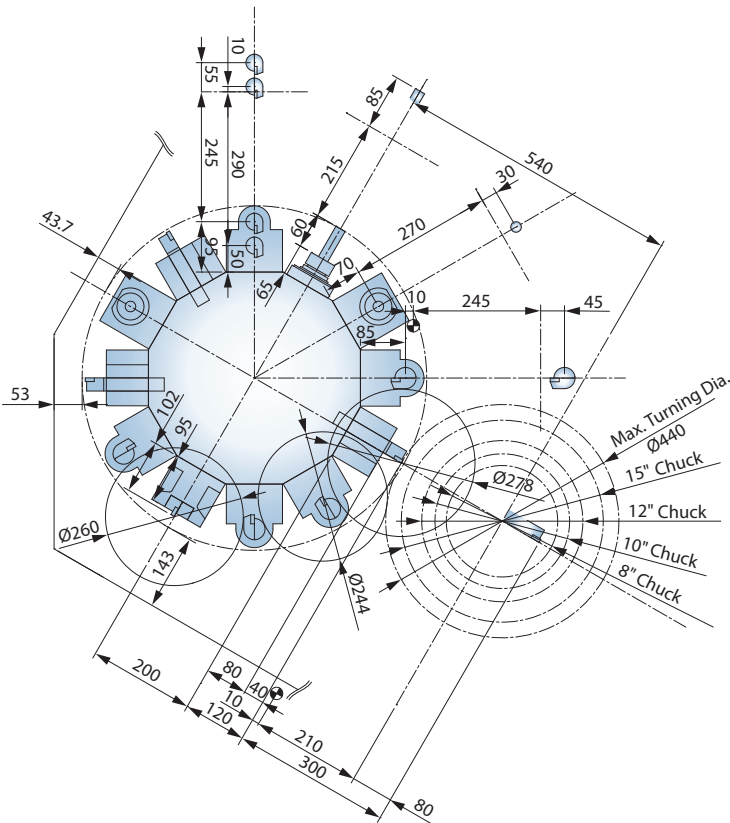

Tooling System

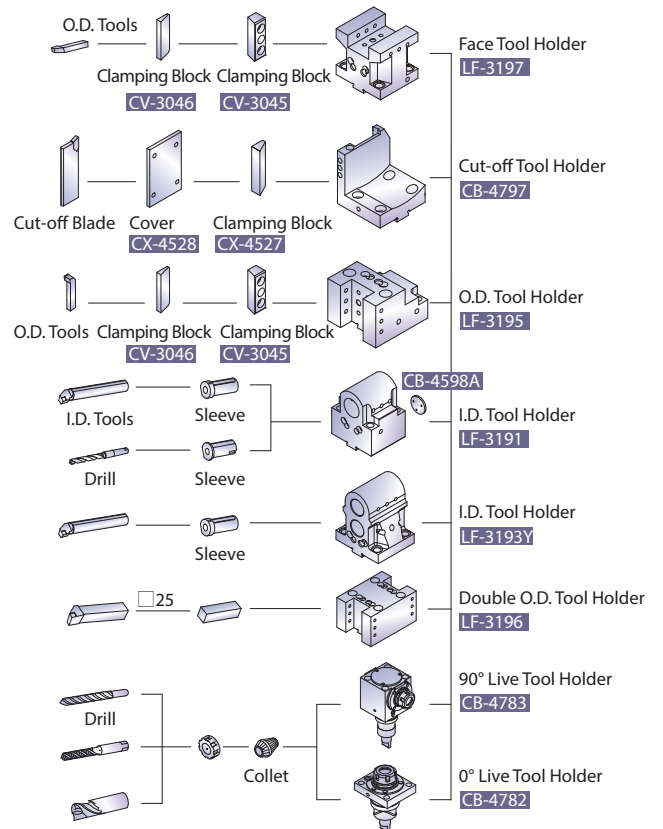
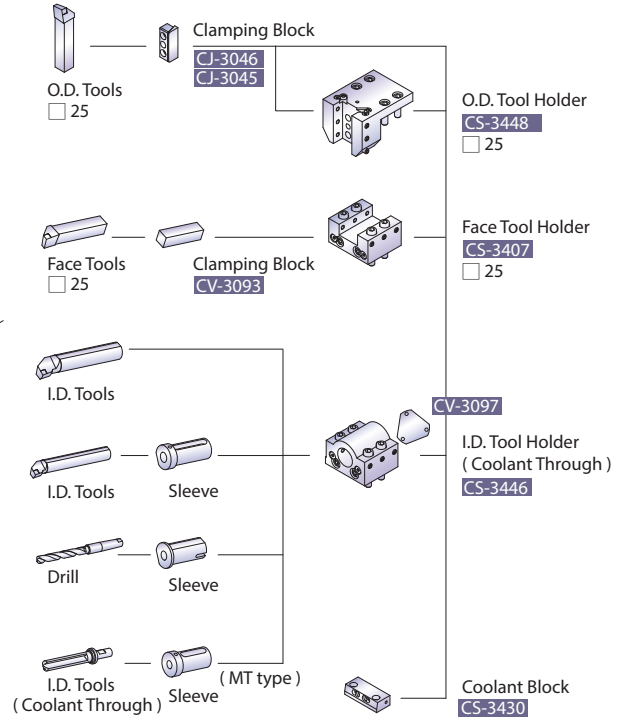

Unit : mm

Interference Diagram

[Y-axis]

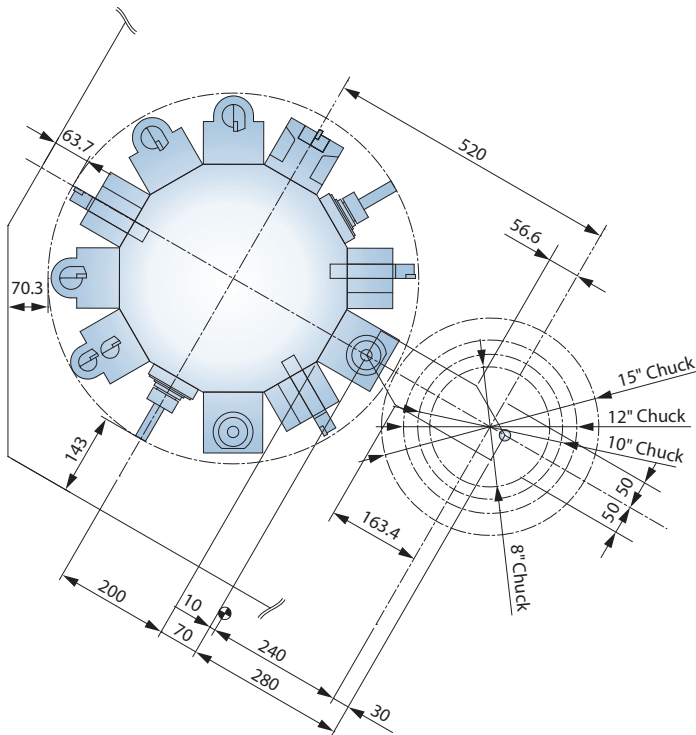
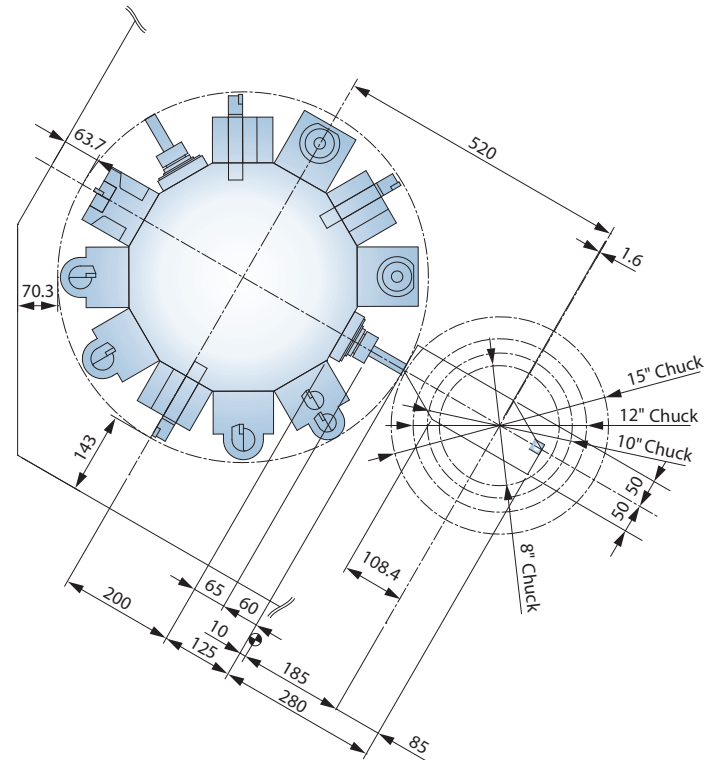
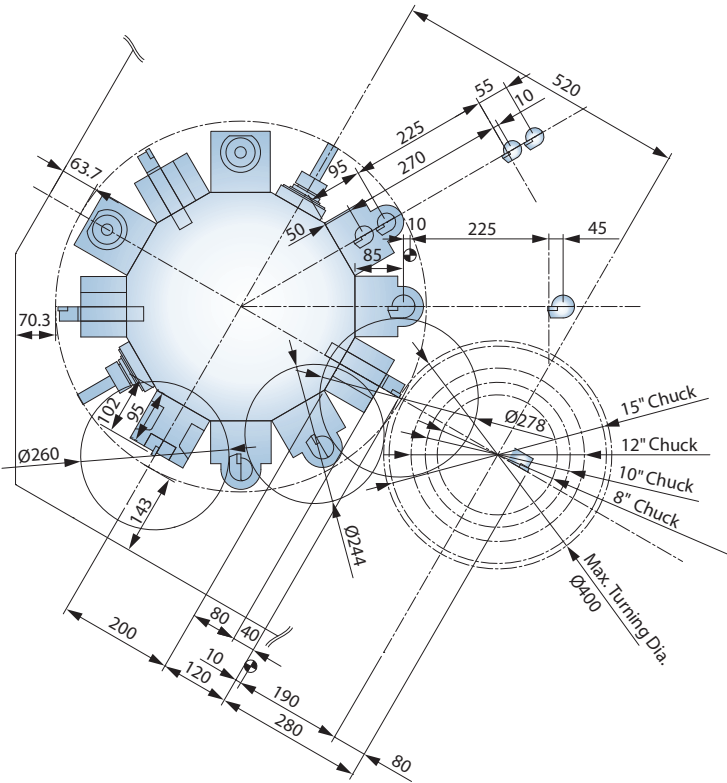

Tooling System

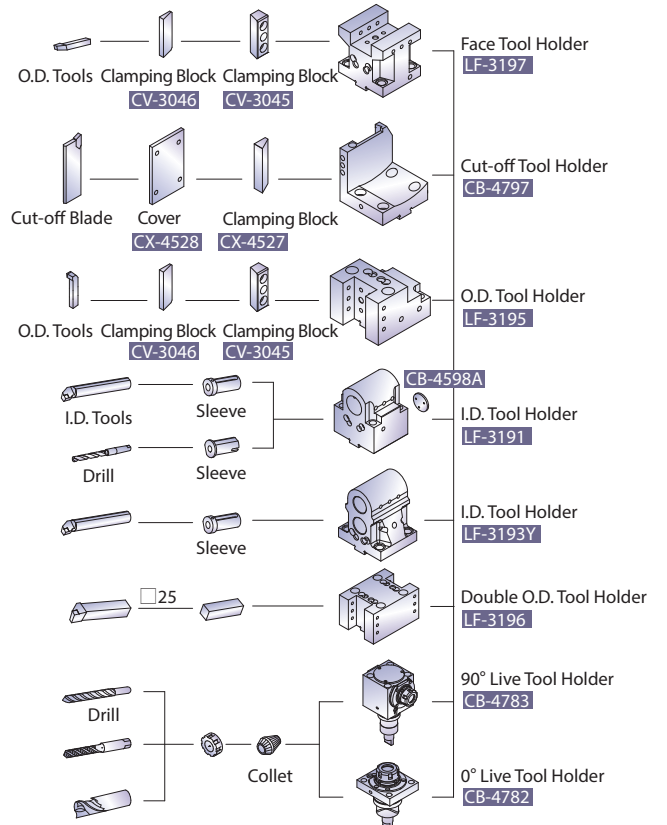

Unit : mm

GS-2000 Series Work Range

[12-Station Turret]

I.D. / O.D. Tools

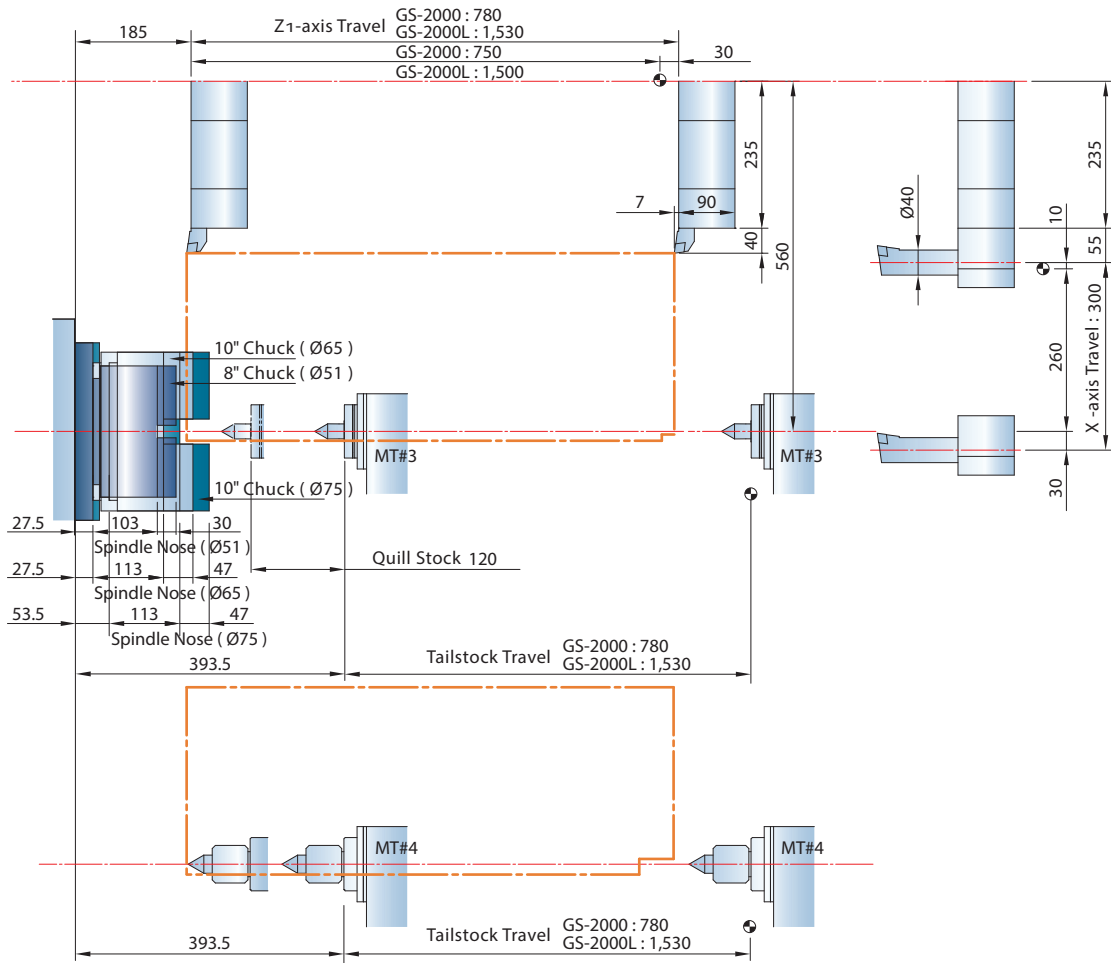

[Sub-spindle]

I.D. / O.D. Tools

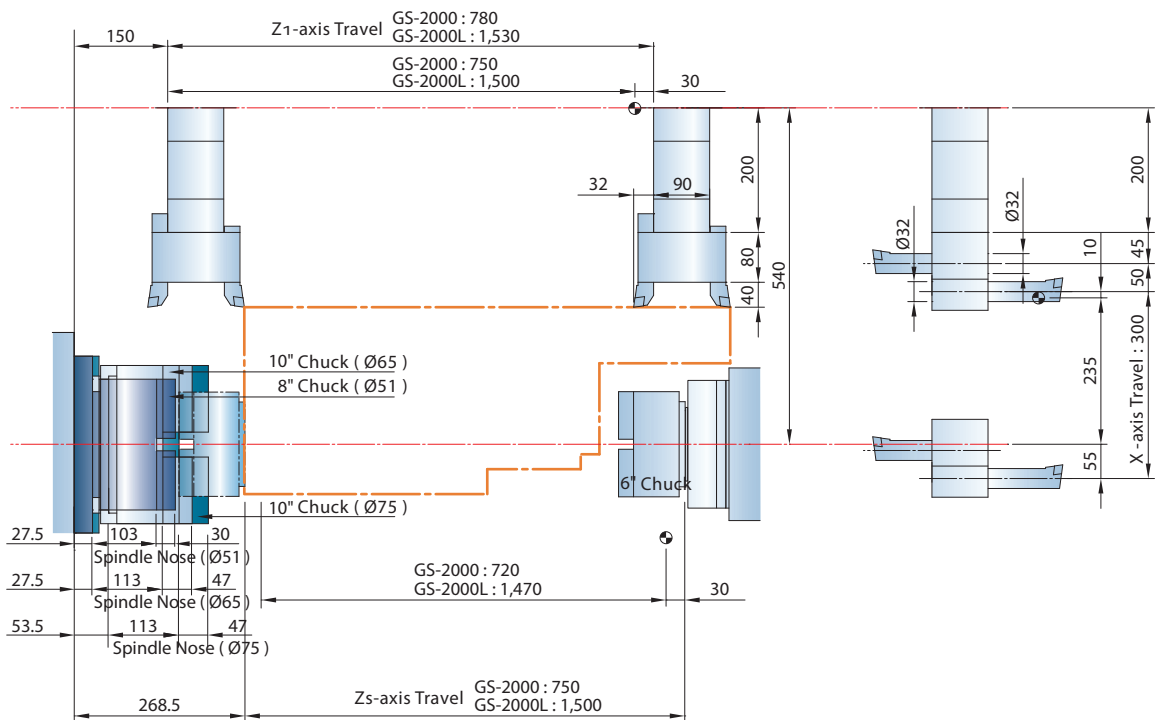

Unit : mm

GS-2000 Series Work Range

[Live Tooling Turret] /
[Y-axis]

I.D. / O.D. Tools

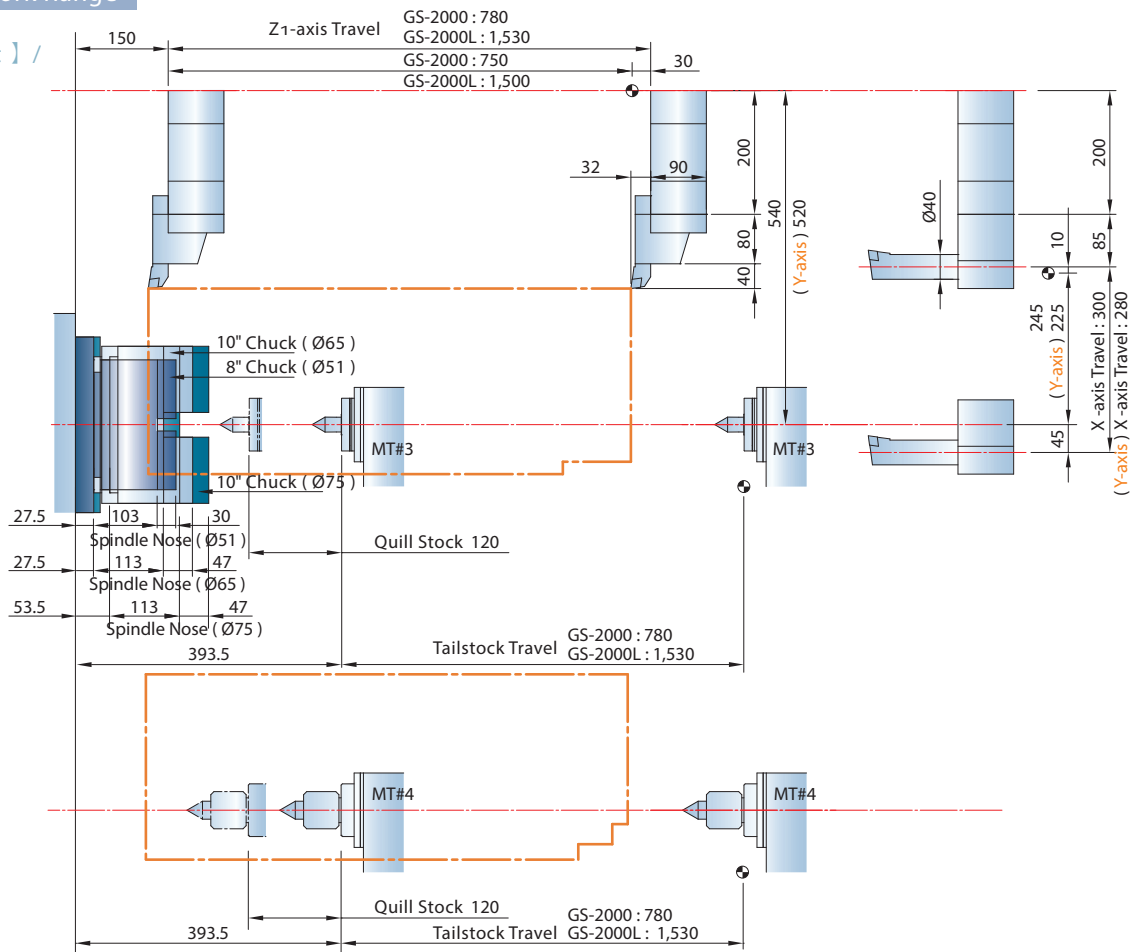

Live Tooling

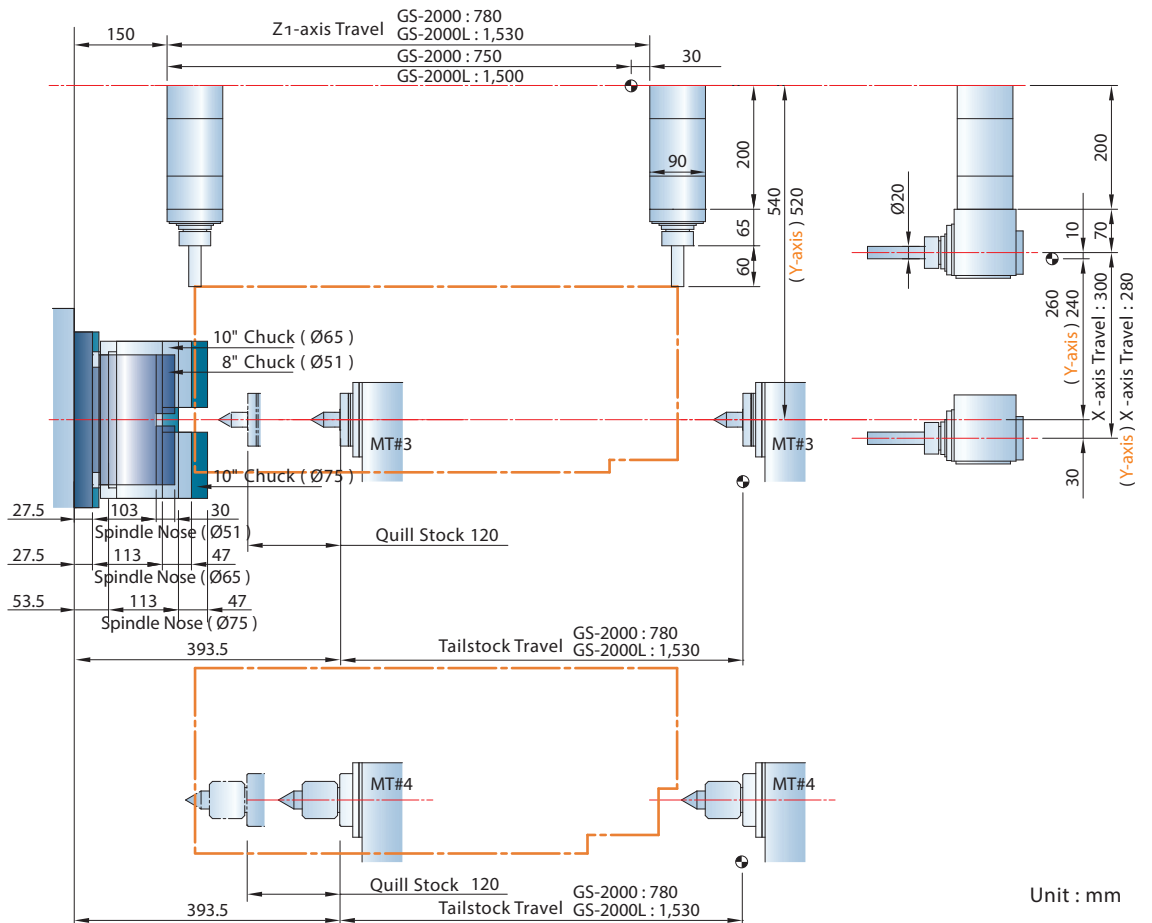

Unit : mm

GS-2000 Series Work Range

[Live Tooling Turret & Sub-spindle] / [Y-axis & Sub-spindle]

I.D. / O.D. Tools

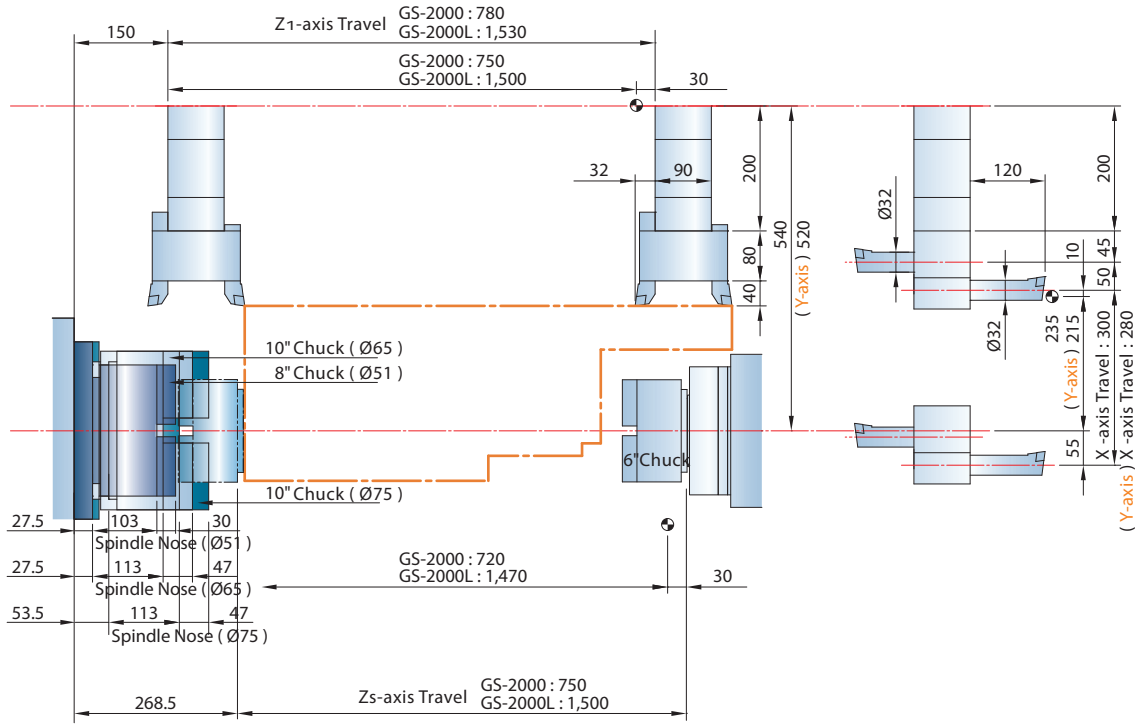

Live Tooling

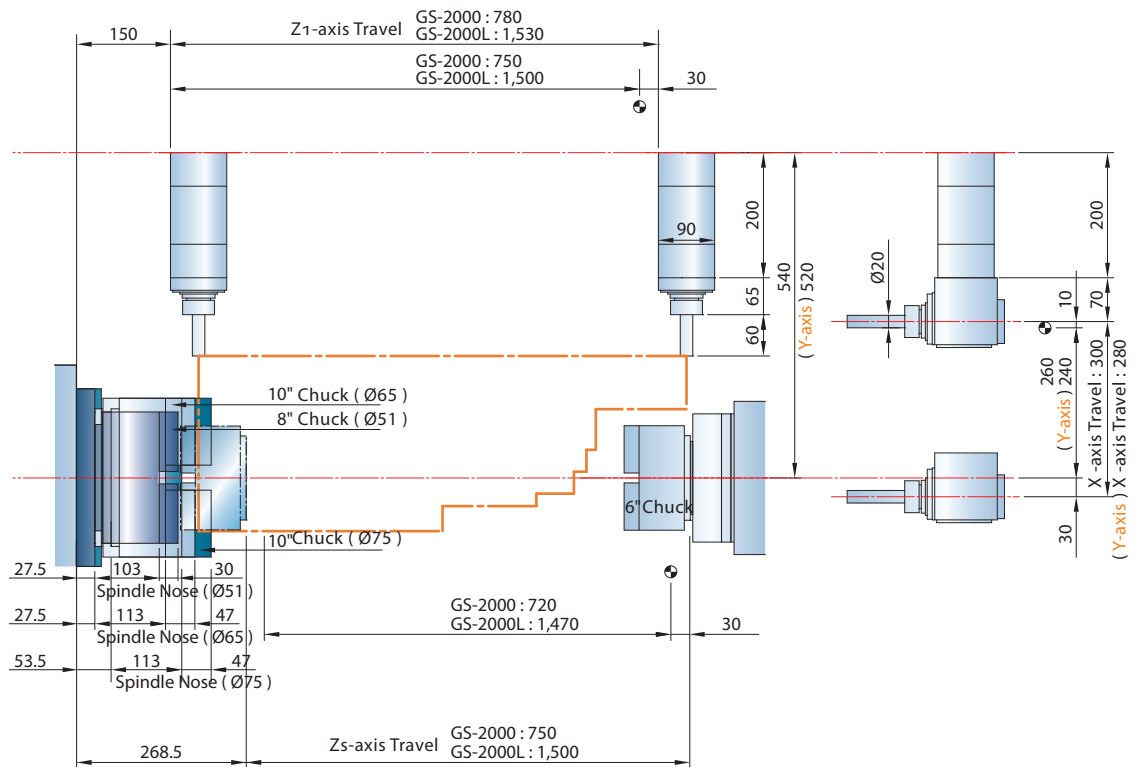

Unit : mm

GS-3000 Series Work Range

[12-Station Turret]

I.D. / O.D. Tools

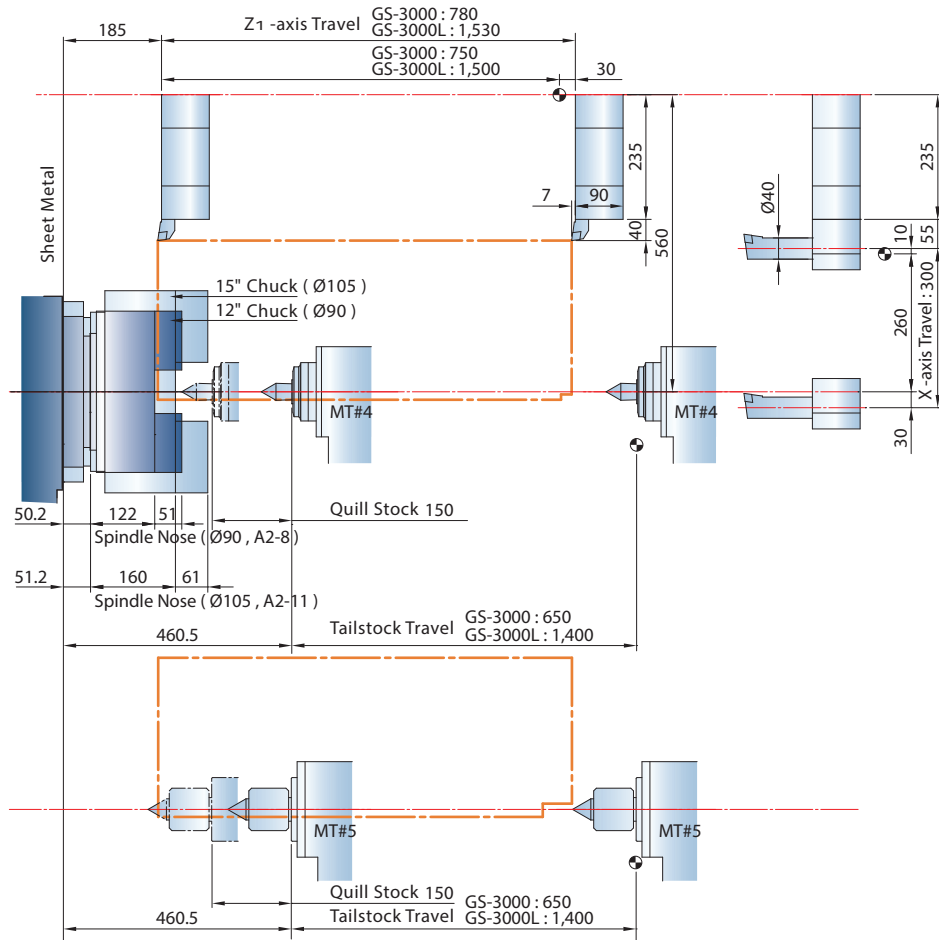

[Sub-spindle]

I.D. / O.D. Tools

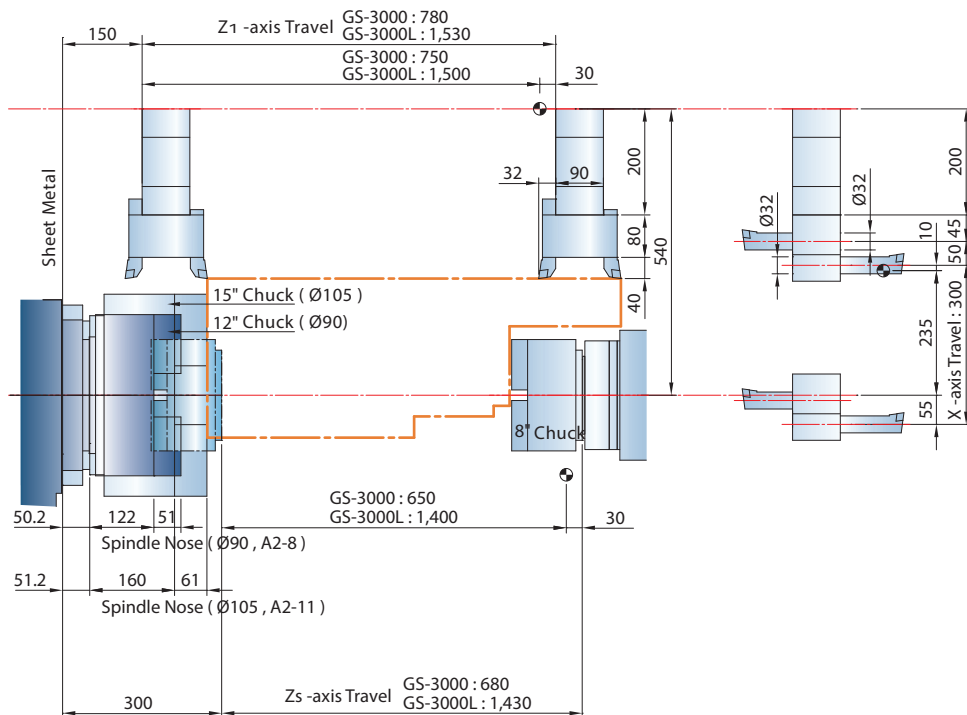

GS-3000 Series Work Range

[Live Tooling Turret] / [Y-axis]

I.D. / O.D. Tools

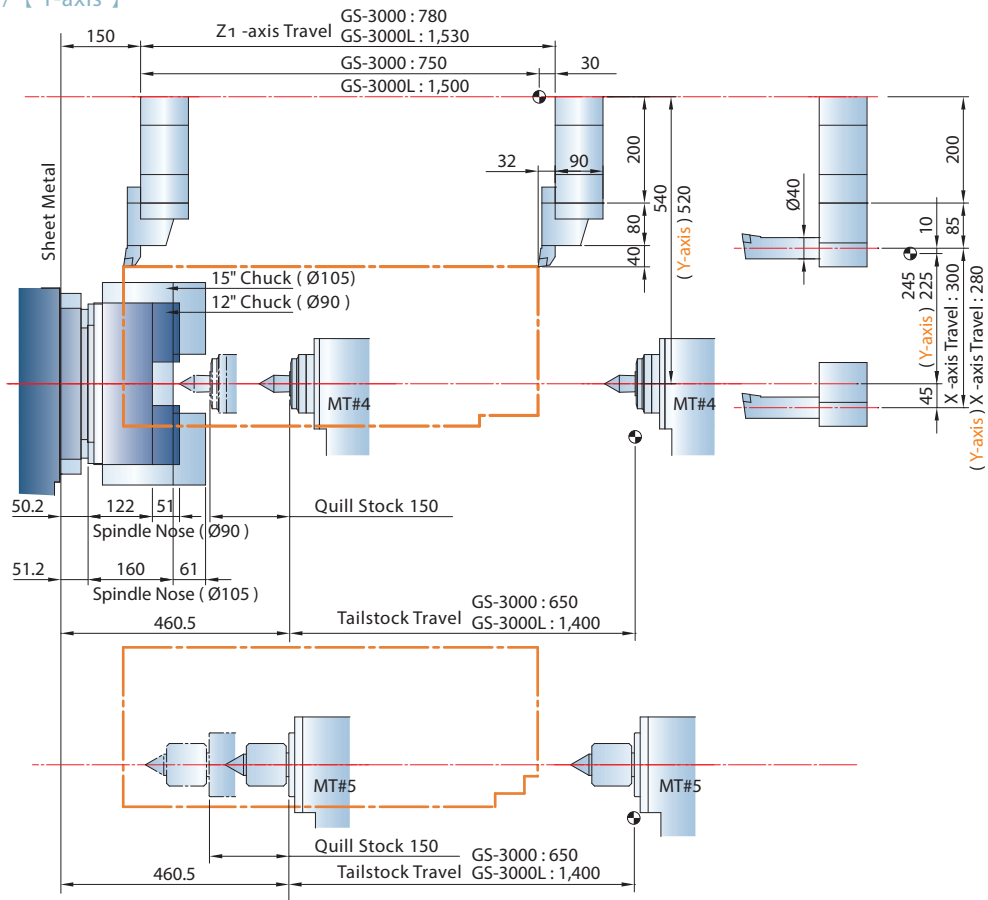

Live Tooling

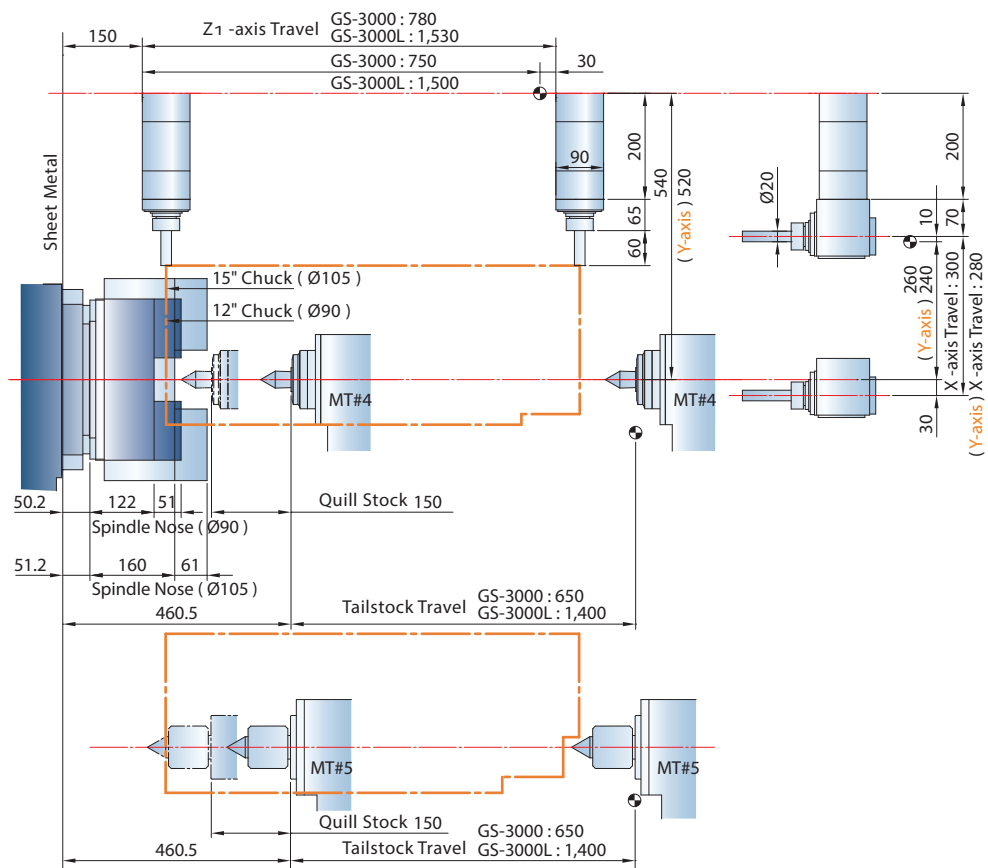

Unit : mm

Space Requirement

21

22

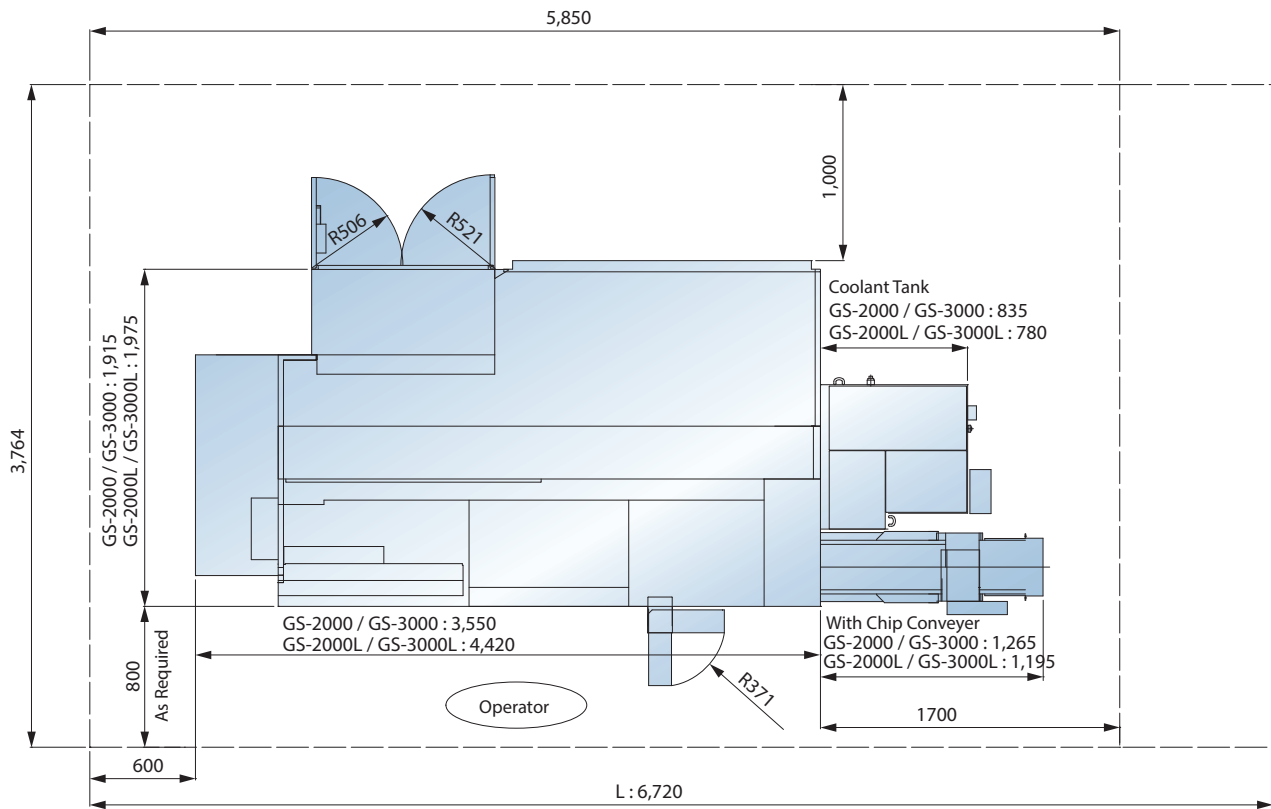

Machine Layout

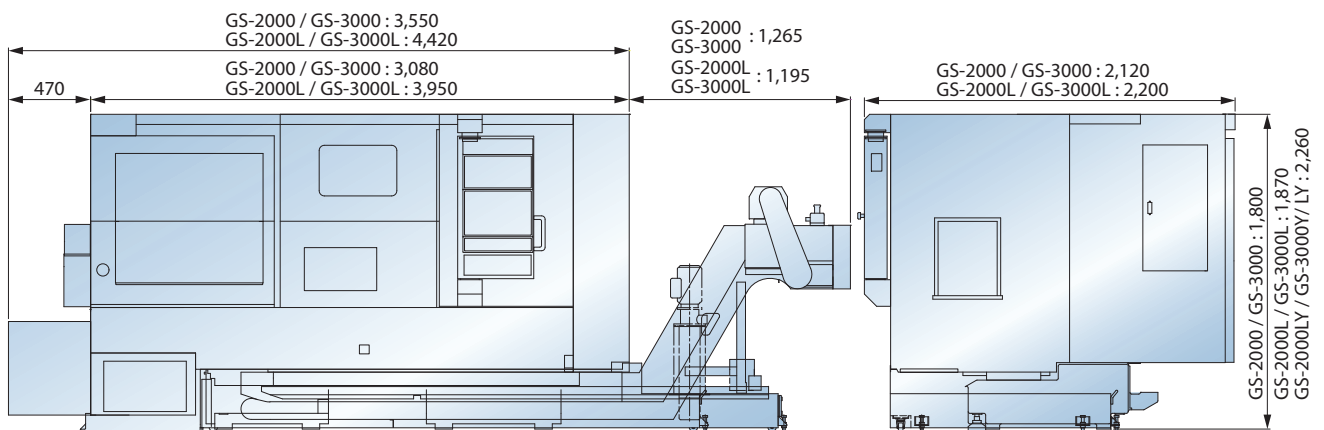

Unit : mm

Foot-Print

GS-2000 / GS-3000

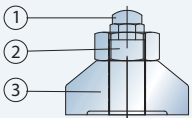
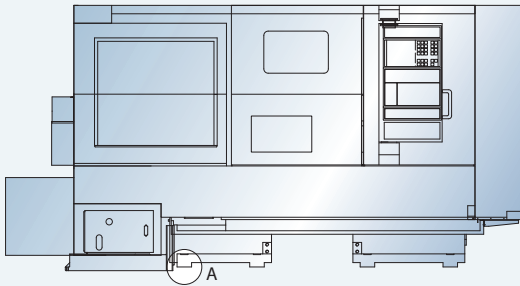

| N0. | Part NO. | Part Name |
|-----|----------|----------------|
| 1 | LG-1022 | Leveling Bolt |
| 2 | NA3000BA | Hex. Nut M30 |
| 3 | LG-1021 | Leveling Block |

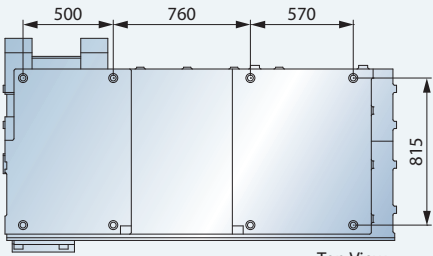

Operator Top View

GS-2000L / GS-3000L

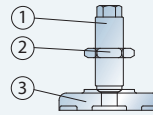
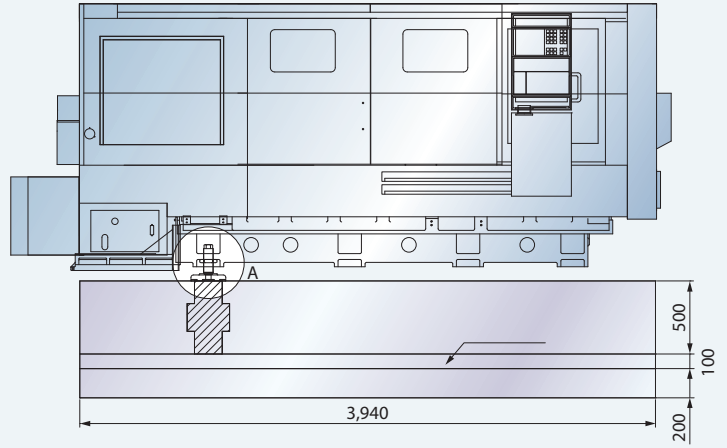

| N0. | Part NO. | Part Name |
|-----|----------|----------------|
| 1 | CA-1029Z | Leveling Bolt |
| 2 | CA-1026 | Hex. Nut M30 |
| 3 | CA-1030 | Leveling Block |

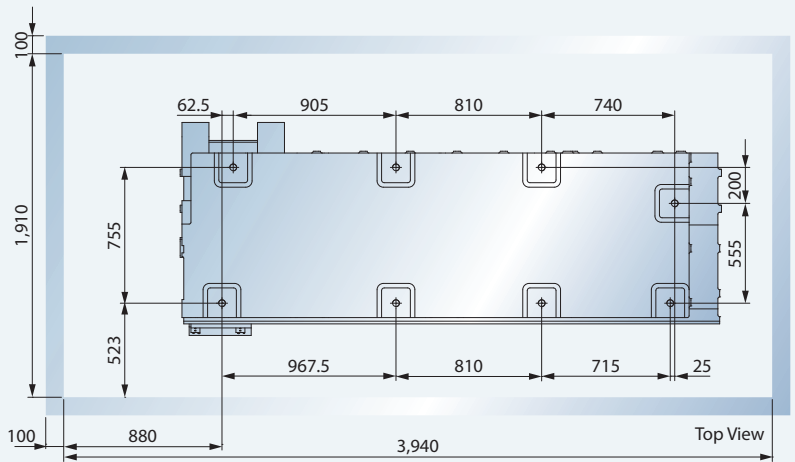

Operator Top View

Lifting by Forklift

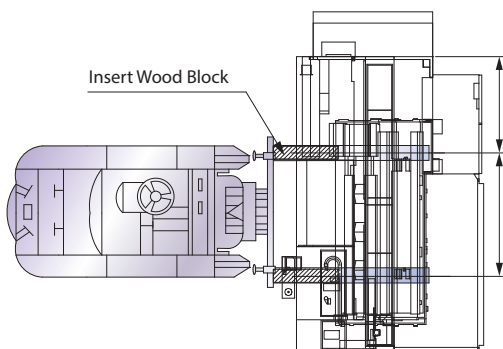

GS-2000 / GS-3000 : 1,295 GS-2000 / GS-3000 : 1,010
 GS-2000L / GS-3000L : 1,640 GS-2000L / GS-3000L : 1,360

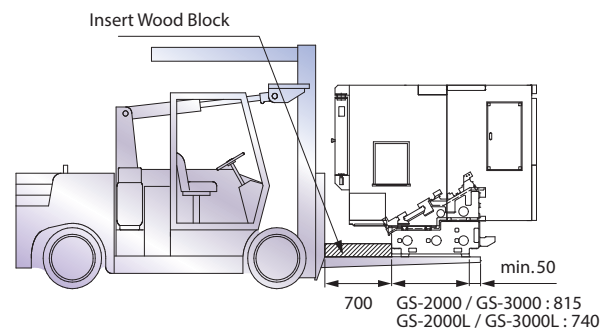

Unit : mm

STANDARD & OPTIONAL FEATURES

S : Standard O : Option
 - : Not available C : Contact GOODWAY

| | | GS-2000 | GS-3000 |
|--|-----------------------|---------|---------|
| SPINDLE | | | |
| Main spindle configuration | Belt-drive | S | S |
| | Built-in | O | O |
| | Gear (GS-3600) | - | C |
| Rigid tapping & spindle orientation | | S | S |
| Disk brake for main spindle | | O | O |
| Cf-axis & disk brake for main spindle*1 | | O | O |
| Sub-spindle | | O | O |
| WORK HOLDING | | | |
| Hydraulic hollow cylinder for chuck | 8" | S*2 | - |
| | 10" | S*2 | O |
| | 12" | O | S |
| | 15" | - | S*2 |
| Hollow 3-jaws chuck & 1 set soft jaws | 8" | S*2 | - |
| | 10" | S*2 | O |
| | 12" | O | S |
| | 15" | - | S*2 |
| Hard jaws | | O | O |
| Collet chuck | | O | O |
| Special work holding chuck | | C | C |
| In spindle work stopper | | O | O |
| Spindle liner (guide bushing) | | O | O |
| Foot switch for chuck operation | | S | S |
| Hydraulic quill & tailstock | | O | O |
| Dead center | MT#3 | S | - |
| | MT#4 | - | S |
| | MT#5 | O | - |
| Live center | MT#4 | O | - |
| | MT#5 | - | O |
| Foot switch for steady rest operation | | O | O |
| Two-stage programmable pressure | Chuck clamping | O | O |
| | Tailstock thrust | O | O |
| TURRET | | | |
| 10-station turret | | O | O |
| 12-station turret | | S | S |
| 12-station live tooling turret | | O | O |
| Tool holder & sleeve package | | S | S |
| Live tooling tool holders (0° x 2 , 90° x 2)*1 | | O | O |
| MEASUREMENT | | | |
| RENISHAW HPRA tool presetter | Removeable | O | O |
| COOLANT | | | |
| Coolant pump | 3 Kg/cm ² | S | S |
| | 5 Kg/cm ² | O | O |
| | 10 Kg/cm ² | O | O |
| High-pressure coolant system | 20 Kg/cm ² | C | C |
| Roll-out coolant tank | | S | S |
| Oil skimmer | | O | O |
| Coolant flow switch | | O | O |
| Coolant level switch | | O | O |
| Coolant intercooler system | | O | O |
| CHIP DISPOSAL | | | |
| Chip conveyor with auto timer | Right discharge | S | S |
| Chip cart with coolant drain | | O | O |
| Chuck air blow | | O | O |
| Tailstock air blow | | O | O |
| Coolant gun | | O | O |
| Oil mist collector | | O | O |
| AUTOMATIC OPERATION SUPPORT | | | |
| Parts catcher | | O | O |
| Work-piece transport conveyor | | O | O |
| Bar feeder | | O | O |
| Bar feeder interface | | O | O |
| Gantry-type loader / unloader | | O | O |
| Auto door | | O | O |
| External M-code output | 4 sets (8) | O | O |
| | 8 sets (16) | O | O |
| SAFETY | | | |
| Fully enclosed guarding | | S | S |
| Door interlock (incl. Mechanical lock) | | S | S |
| Impact resistant viewing window | | S | S |
| Tailstock stroke out-end check | | S | S |
| Chuck cylinder stroke out-end check | | S | S |
| Chuck cylinder check valve | | S | S |
| Low hydraulic pressure detection switch | | S | S |
| Over travel (soft limit) | | S | S |
| Load monitoring function*3 | | O | O |

| | | GS-2000 | GS-3000 |
|---|--------------------|---------|---------|
| OTHERS | | | |
| Tri-color machine status light tower | | S | S |
| Work light | | S | S |
| External work light | | O | O |
| Electrical cabinet | Heat exchanger | S | S |
| | A/C cooling system | O | O |
| Complete hydraulic system | | S | S |
| Advanced auto lubrication system | | S | S |
| Foundation leveling & maintenance tool kit | | S | S |
| Emergency maintenance electrical part package | | S | S |
| Operation & maintenance manuals | | S | S |

| | | O _i -TF | 31 _i |
|--|-----------------|--------------------|-----------------|
| FANUC CONTROL FUNCTIONS | | | |
| Display | 8.4" color LCD | S | O |
| | 10.4" color LCD | O | S |
| Graphic function | Standard | S | S |
| | Dynamic | O | O |
| Part program storage size | 512K bytes | S | - |
| | 1M bytes | O | S |
| O _i -TF : each path | 2M bytes | O | O |
| 31 _i : total | 4M bytes | - | O |
| | 8M bytes | - | O |
| Registerable programs | 400 | S | - |
| | 1,000 | O | S |
| O _i -TF : each path | 4,000 | - | O |
| | 99 | - | S |
| 31 _i : total | 128 | S | - |
| | 200 | O | O |
| | 400 | - | O |
| | 499 | - | O |
| Tool offset pairs | 999 | - | O |
| | 2000 | - | O |
| | HRV 3 | S | S |
| Servo HRV control | | S | S |
| Automatic data backup | | S | S |
| Synchronous / Composite control | | O | O |
| Inch / metric conversion | | S | S |
| Polar coordinate interpolation | | S | S |
| Cylindrical interpolation | | S | S |
| Multiple repetitive cycle | | S | S |
| Rigid tapping | | S | S |
| Unexpected disturbance torque detection function | | S | S |
| Spindle orientation | | S | S |
| Spindle speed fluctuation detection | | S | S |
| Embedded macro | | O | O |
| Spindle synchronous control | | S | S |
| Tool radius / Tool nose radius compensation | | S | S |
| Multi-language display | | S | S |
| Polygon turning | | S | S |
| Helical interpolation | | O | O |
| Direct drawing dimension programming | | S | S |
| Thread cutting retract | | S | S |
| Variable lead threading | | S | S |
| Multiple repetitive cycle II | | S | S |
| Canned cycles for drilling | | S | S |
| Tool nose radius compensation | | S | S |
| Chamfering / Corner R | | S | S |
| AI contour control I | | O | S |
| Multi part program editing*4 | | S | S |
| Manual handle retrace | | O | O |
| Manual intervention and return | | S | O |
| External data input | | S | S |
| Addition of custom macro | | S | S |
| Increment system C | | S | S |
| Run hour & parts counter | | S | S |
| Auto power-off function | | S | S |
| RS-232 port | | S | S |
| Memory card input / output (CF + USB) | | S | S |
| Ethernet | | S | S |

*1 Available for live tooling turret or Y-axis model.
 *2 Individual models may vary.
 *3 Cannot coexist with MANUAL GUIDE *i*
 *4 10.4" LCD option needed
 Specifications are subject to change without notice.

MACHINE SPECIFICATIONS

■ : Metric ■ : Inch

| CAPACITY | GS-2000 / L | GS-2600 / L | GS-2800 / L | GS-3300 / L | GS-3600 / L |
|---|---|-----------------------------------|---|-----------------------------------|----------------------------------|
| Max. swing diameter (door) | | | Ø 700 mm 27.55" | | |
| Swing over saddle | | | Ø 800 mm 31.5" | | |
| Max. turning diameter | | | Ø 570 mm 22.44" | | |
| Std. turning diameter | Standard turret : Ø 250 10" / Live tooling turret : Ø 278 mm 10.94" | | | | |
| Max. turning length*1 | 780 / 1,530 mm 30.7" / 60.24" | 780 / 1,530 mm 30.7" / 60.24" | 780 / 1,530 mm 30.7" / 60.24" | 780 / 1,530 mm 30.7" / 60.24" | 746 / 1,496 mm 29.37" / 58.9" |
| Chuck size | 8" | 10" | 10" | 12" | 15" |
| Bar capacity | Ø 51 mm 2" | Ø 65 mm 2.5" | Ø 75 mm 2.9" | Ø 90 mm 3.5" | Ø 105 mm 4.1" |
| SPINDLE | | | | | |
| Hole through draw tube | Ø 52.5 mm 2" | Ø 65.5 mm 2.5" | Ø 75.5 mm 2.9" | Ø 90.5 mm 3.5" | Ø 105.5 mm 4.1" |
| Hole through spindle | Ø 65 mm 2.5" | Ø 76 mm 3" | Ø 90 mm 3.5" | Ø 101 mm 3.97" | Ø 121 mm 4.76" |
| Spindle bearing diameter | Ø 100 mm 3.93" | Ø 120 mm 4.72" | Ø 130 mm 5.12" | Ø 140 mm 5.51" | Ø 160 mm 6.3" |
| Hydraulic cylinder | 8" | 10" | 10" | 12" | 15" |
| Spindle nose | A2-6 | | A2-8 | | A2-11 |
| Motor output (Cont. / 30 min.) | 15 / 18.5 kW 20 / 25 HP | | 15 / 18.5 kW 20 / 25 HP (Opt. 18.5 / 22 kW) (25 / 30 HP) | 18.5 / 22 kW 25 / 30 HP | |
| Spindle drive system | Belt-drive | | | | |
| Spindle speed ranges | 4,800 rpm | 4,000 rpm | 3,500 rpm | 3,000 rpm | 2,500 rpm |
| Spindle full output speed | 460 rpm | 383 rpm | 335 rpm | 403 rpm | 261 rpm |
| Spindle torque (Cont. / 30 min.) | 311 / 384 Nm 229 / 283 lb-ft | 374 / 461 Nm 275 / 340 lb-ft | 428 / 527 Nm 315 / 388 lb-ft | 438 / 521 Nm 323 / 384 lb-ft | 677 / 805 Nm 499 / 593 lb-ft |
| C-AXIS SPINDLE (OPTIONAL) | | | | | |
| Drive type | Cf | | | | |
| C-axis rapids | 33 rpm | | | | |
| X & Z AXES | | | | | |
| Max. X-axis travel | 300 mm 11.8" | | | | |
| Max. Z-axis travel | 780 / 1,530 mm 30.7" / 60.24" | | | | |
| X / Z axes rapids | 30 m/min. 1,181 IPM | | | | |
| Slide way type | Hardened & Ground Box Ways | | | | |
| Feed rates | 1 ~ 4,800 mm/min. 1 ~ 189 IPM | | | | |
| X / Z axes servo motor | 4.5 / 4.5 kW 6 / 6 HP | | | | |
| X-axis ball screw Ø [pitch] | Ø 36 mm [10 mm] Ø 1.42" [0.39"] | | | | |
| Z-axis ball screw Ø [pitch] | Ø 36 mm [10 mm] / Ø 40 mm [12 mm] Ø 1.42" [0.39"] / Ø 5.51" [0.47"] | | | | |
| X-axis thrust (Cont.) | 769 Kgf 1,695 lbf | | | | |
| Z-axis thrust (Cont.) | 1,409 / 1,174 Kgf 3,106 / 2,588 lbf | | | | |
| TURRET | | | | | |
| Stations | 12 | | | | |
| Indexing speed | 0.3 sec. Adjacent / 0.8 sec. (Single step) | | | | |
| Accuracy | Positioning : ± 0.00069°, Repeatability : ± 0.00027° | | | | |
| OD tool shank size | □ 25 mm 1" | | | | |
| ID tool shank size | Ø 40 mm 1-1/2" | | | | |
| LIVE TOOLING TURRET (OPTIONAL) | | | | | |
| Max. turning diameter | Ø 440 mm 17.32" | | | | |
| Max. turning length*1 | 750 / 1,517 mm 29.53" / 59.72" | 750 / 1,507 mm 29.53" / 59.33" | 731 / 1,480 mm 28.78" / 58.27" | 725 / 1,475 mm 28.54" / 58.07" | 686 / 1,436 mm 27" / 56.54" |
| Live tooling stations | 12 | | | | |
| Live tooling drive motor | 4.5 kW 6 HP | | | | |
| Indexing speed | 0.3 sec. Adjacent / 0.8 sec. (Single step) | | | | |
| OD tool shank size | □ 25 mm 1" | | | | |
| ID tool shank size | Ø 40 mm 1-1/2" | | | | |
| Live tooling shank size | ER 32 (Ø 20 mm) 3/4" | | | | |
| Live tooling RPM range | 4,000 rpm | | | | |

■ : Metric ■ : Inch

25

26

| Y-AXIS (OPTIONAL) | GS-2000 / L | GS-2600 / L | GS-2800 / L | GS-3300 / L | GS-3600 / L |
|-----------------------------|-------------------------------------|-------------|-------------|-------------|-------------|
| Max. turning diameter | Ø 400 mm 15.75" | | | | |
| Max. Y-axis travel | 100 mm = ± 50 mm 4" = ± 2" | | | | |
| Y-axis rapids | 10 m/min. 393 IPM | | | | |
| Feed rates | 1 ~ 4,800 mm/min. 1 ~ 189 IPM | | | | |
| X / Y axes servo motor | 4.5 / 4 kW 6 / 5.3 HP | | | | |
| X-axis ball screw Ø / pitch | Ø 36 mm [10 mm] Ø 1.42" [0.39"] | | | | |
| Y-axis ball screw Ø / pitch | Ø 32 mm [8 mm] Ø 1.26" [0.31"] | | | | |
| X / Y axes thrust (Cont.) | 1,409 / 1,761 Kgf 3,106 / 3,882 lbf | | | | |

TAILSTOCK

| | | | | |
|---------------------------|--|--|--|--|
| Quill center taper | Quill programmable tailstock : MT#3 (Dead center , Quill diameter Ø 85 mm 3.35") MT#4 (Live center , Quill diameter Ø 85 mm 3.35") | | Quill programmable tailstock : MT#4 (Dead center , Quill diameter Ø 110 mm 4.33") MT#5 (Live center , Quill diameter Ø 120 mm 4.72") | |
| | Servo tailstock (Opt.) : MT#3 (Dead center , Quill diameter Ø 80 mm 3.15") MT#4 (Live center) | | | |
| Quill travel | Quill programmable tailstock : 120 mm 4.72" | | Quill programmable tailstock : 150 mm 5.9" | |
| | Servo tailstock (Opt.) : — | | Servo tailstock (Opt.) : — | |
| Tailstock base travel | Quill programmable tailstock : 780 / 1,530 mm 30.7" / 60.24" | | Quill programmable tailstock : 650 / 1,400 mm 25.6" / 66.93" | |
| | Servo tailstock : 740 / 1,490 mm 29.13" / 58.66" | | Servo tailstock : 700 / 1,450 mm 27.56" / 57.09" | |
| Programmable quill / base | Quill programmable tailstock : Yes / Yes Servo tailstock : — / Yes | | | |

SUB-SPINDLE (OPTIONAL)

| | | | | |
|--------------------------------|---|--|---|--|
| Chuck size | 6" | | 8" | |
| Hole through draw tube | Ø 38 mm 1.49" | | Ø 45 mm 1.77" | |
| Hole through spindle | Ø 46 mm 1.81" | | Ø 55 mm 2.16" | |
| Spindle bearing diameter | Ø 80 mm 3.15" | | Ø 100 mm 3.94" | |
| Spindle nose | A2-5 | | A2-6 | |
| Motor output | 5.5 / 7.5 kW (Cont. / 30 min.) 7.3 / 10 HP | | 15 / 18.5 kW (Cont. / 15 min.) 20 / 25 HP | |
| Spindle drive system | Built-in motor | | Built-in motor | |
| Spindle speed range | 6,000 rpm | | 5,000 rpm | |
| Spindle torque | 35 / 48 Nm (Cont. / 30 min.) 25 / 35 lb-ft | | 95 / 118 Nm (Cont. / 15 min.) 70 / 87 lb-ft | |
| Zs-axis travel | 680 / 1,430 mm 26.77" / 56.3" | | | |
| Zs-axis rapid | 30 m/min. 1,181 IPM | | | |
| Slide way type | Linear guide way | | | |
| Zs-axis servo motor | 3 kW 4 HP | | | |
| Zs-axis ball screw Ø [pitch] | Ø 36 mm [10 mm] / Ø 40 mm [12 mm] Ø 1.42" [0.39"] / Ø 5.51" [0.47"] | | | |
| Zs-axis thrust (Cont.) | 769 / 640 Kgf 1,695 / 1,410 lbf | | | |

GENERAL

| | | | | |
|-----------------------------|---|--|--|--|
| Repeatability on X-axis | ± 0.003 mm ± 0.00012" | | | |
| Repeatability on Z-axis | ± 0.003 mm ± 0.00012" | | | |
| Standard CNC control | FANUC Oi-TF (Opt. 31 i) | | | |
| Voltage / Power requirement | AC 200/220 / 40 KVA | | | |
| Hydraulic tank capacity | 30 L 7.9 gal | | | |
| Coolant tank capacity | 290 / 330 L 76 / 87 gal | | | |
| Coolant pump | 0.7 kW 1 HP (60 Hz) rated at 3 bar (44 PSI) | | | |
| Machine weight | 6,500 / 8,500 Kg 14,400 / 18,800 lb | | | |
| Dimensions L × W × H | 3,550 x 2,120 x 1,800 / 4,420 x 2,200 x 1,870 mm 140" x 86.5" x 70.9" / 175" x 87" x 73.6" Y-axis model : 3,550 x 2,120 x 2,260 / 4,420 x 2,200 x 2,260 mm 140" x 86.5" x 89" / 175" x 87" x 89" | | | |

Specifications are subject to change without notice.

*1 Maximum turning length may vary, based on the chuck size chosen.



GOODWAYCNC.com

GOODWAY MACHINE CORP.

HEADQUARTERS

No.13, 5th Road,
Taichung Industrial Park,
Taichung City, 407, Taiwan.
E-mail : goodway@goodwaycnc.com

CENTRAL TAIWAN SCIENCE PARK BRANCH

No. 38, Keyuan Road,
Central Taiwan Science Park.Taichung,
Taichung City, 407, Taiwan.
TEL : + 886-4-2463-6000
FAX : + 886-4-2463-9600

GOODWAY MACHINE (WUJIANG) CO.,LTD

No. 4888, East Lake Taihu Avenue, Wujiang
Economic and Technological Development Zone,
Jiangsu, China
Sales Hotline : + 86-512-8286-8068
Service Hotline : + 86-512-8286-8066
FAX : + 86-512-8286-8620
E-mail : goodway@goodwaycnc.cn